

CHAPTER 13 - AVIATION OPHTHALMOLOGY

1 INTRODUCTION

This chapter is devoted to the assessment of visual functions in relation to aviation duties and to principles of ophthalmological examination techniques. The medical examiner should be familiar with the visual capacity required in various aviation duties and the necessity for a detailed special examination in certain cases.

This guidance material is intended to be applied in conjunction with the Ophthalmological Requirements and thus has regulatory implication; its main purpose is to aid in the implementation of provisions of the Medical Requirements. It intends to aid in the assessment of normal, presumably healthy applicants at initial or periodic examination, and applicants in whom there is a suspicion, or overt manifestation, of symptoms of disturbed visual function or eye disease. The aim is to achieve a measure of European uniformity of procedures and comparable results in the assessment of both normal and borderline cases.

1.1 Effect of the flight environment

The effectiveness of the visual system is of utmost importance if air crew and air traffic control personnel are to carry out their duties safely and efficiently.

In the case of air crew, the effect of the flight environment influences the visual function by virtue of the following factors:

- a Altitude
- b Cockpit illumination
- c Speed
- d Acceleration
- e Vibration.

Environmental factors specific for air crew may reduce the visual performance to a degree not ordinarily experienced in normal ground tasks and should be taken into account accordingly.

With increasing flight altitude, the normal environmental light distribution reverses; when flying over clouds sunlight is reflected so that the lower part of the visual field is brighter than the upper one. At higher altitudes, the sky becomes more and more dark. The contrast glare thereby created makes reading the instrument panel difficult.

Most commercial aircraft are independent of ambient oxygen pressure due to pressurisation of the cabin. A slight degree of hypoxia, however, as experienced even in pressurised aircraft may influence visual fields, visual acuity, dark adaptation, and fusional range.

If contact lenses are used, the reduced oxygen pressure experienced during long distance flying may result in corneal hypoxia leading to corneal oedema and reduced visual acuity. The low air humidity on the flight deck further aggravates the problems induced by the low oxygen tension and may cause dry eye symptoms even in non-contact lens users.

Space myopia (empty field myopia) may occur at altitude due to scarceness of visual targets outside the cockpit. When there are no objects to fixate, the eyes of some people tend to accommodate thus becoming myopic to a degree of up to 1.5 dioptres. In practice, difficulties may arise when searching for other aircraft, especially at very high altitudes.

Cockpit illumination may produce visual problems for several reasons. At low illumination levels, the visual acuity is reduced and the depth of focus decreased due to the pupillary dilatation. This way presbyopic problems are enhanced. Also colour discrimination deteriorates making the reading of colour maps more difficult. Red light illumination causes even more problems with colours and may also induce a relative hypermetropia (as long wavelengths are less refracted in the ocular media).

It is generally not necessary to reduce cockpit illumination to a level corresponding to a deep mesopic or scotopic adaptation. (Under daylight conditions, only the cones of the retina are in operation and under full dark adaptation only the rods. Mesopic vision is an adaptational level in-between with both cones and rods functioning. It ranges from weak daylight to moonlight.) Most of the in-flight information in commercial aviation is provided by instruments. Likewise the runway illumination on international aerodromes is of such a standard that signals are seen without dark adaptation. In special situations, however, a certain degree of dark adaptation may be required for the correct identification of objects outside the aircraft.

The high speeds of modern aircraft at take-off, cruising and landing put special demands on the visual system. We have good reason to believe that dynamic visual skills, i.e. dynamic visual acuity and the threshold for angular motion is of greater importance than the static skills under these circumstances. The pronounced decrease in dynamic visual ability after the age of 50 to 60 years is of great concern in older pilots.

The effect of high acceleration forces is of minor importance in civil aviation. Under special conditions, however, such as tight manoeuvring in aerobatics or agricultural flying, visual disturbances (greyout, blackout) due to high G-forces may be encountered. Visual problems are likely to occur at positive accelerations greater than 3.5 G (+3.5 Gz) and lasting more than 6–12 seconds.

Vibration, especially within the 22–64 Hz range, may cause difficulties in reading instruments or printed material. In practice, problems arise under special operational conditions such as in helicopters. Vibration within the range of 2–10 Hz encountered in turbulence or on rough runways has a significant detrimental effect on visual performance.

1.2 Visual flight deck tasks

The main visual tasks of the pilot are the following:

- a Distance visual tasks
- b Intermediate and near vision tasks
- c Spatial orientation
- d Processing coloured information.

Based on the necessity of the pilot to be able to perform these tasks reliably, Visual Requirements have been established within the following areas:

- a Distance visual acuity
- b Near vision
- c Visual fields
- d Binocular function
- e Colour perception.

The purpose of the aeromedical eye examination is twofold: to confirm that the visual requirements are fulfilled, and to exclude the presence of eye pathology.

At the first aeromedical examination (see JAR–FCL 3.215(b) Ophthalmological Requirements and paragraph 2 of Appendix 12 to this subpart), a comprehensive ophthalmological examination shall be carried out by or under the guidance and supervision of a specialist in aviation ophthalmology acceptable to the AMS.

At subsequent aeromedical renewal examinations a routine ophthalmological examination must be performed at certain intervals (see JAR–FCL 3.215(d) Ophthalmological Requirements and paragraph 4 of Appendix 12 to this subpart).

At each aeromedical renewal examination, an assessment of the visual fitness of the pilot must be performed and the eyes must be examined with regard to possible pathology (see JAR–FCL 3.215(c) Ophthalmological Requirements and paragraph 3 of Appendix 12 to this subpart). All doubtful cases should be referred to a specialist in aviation ophthalmology.

1.3 Examination techniques

The eye examination should include a careful history, a clinical examination, and a precise measurement of the visual capacity.

Certain findings in the history should entail that the applicant is submitted to a more extensive examination, viz.:

- a eye injuries or eye operations
- b regular use of drops or ointments
- c photophobia or the constant use of tinted glasses
- d irritation or itching of the eyes
- e current or previous use of spectacles or contact lenses
- f eye strain or headache, for instance if caused by close work
- g diplopia
- h impairment of vision under reduced illumination.

Information about hereditary eye diseases should be sought, e.g. tapeto-retinal degenerations (retinitis pigmentosa), corneal dystrophies, cataract, and glaucoma. Problems may later arise from manifestations of such diseases.

At the renewal examinations, the applicant should be questioned about visual symptoms occurring under flight such as the need for tinted glasses (clouding of the ocular media), eye pain or irritation, diplopia, blurred vision, and difficulties with contact lenses or spectacles.

The clinical examination of the eyes and their adnexa should include the position and mobility of the lids, the condition of the eyelid margins and eyelashes, signs of epiphora, the position and movements of the globes, scars and other signs of previous trauma or inflammations, and abnormalities of the normal red pupillary light reflex. Signs of acute inflammatory processes are usually overt: congestion, lacrimation, blepharospasm, irregular pupils etc. Any abnormality should be further evaluated by an ophthalmologist.

The assessment of the various visual functions is detailed in the sections to follow.

2 VISUAL ACUITY

The measurement of visual acuity serves a double purpose: to tell whether the visual system as a whole is working properly and to measure the subject's ability to visually separate or identify details or small objects. In relation to the test effort necessary, probably no other test is so informative.

In practice, visual acuity means detection, resolution ability or recognition. In its strictest sense, visual acuity is the resolving power of the visual system, i.e. the ability to see two or more dots, lines or other objects as separate and not confluent. Tests based on this principle are tedious and cumbersome. Therefore the easier-used letters have become the mostly used objects for testing visual acuity. With these, recognition and other cognitive factors also come into play. Although letter identification is a complex task, testing is easy and the results very informative as to the visual function.

Many attempts have been made to achieve an internationally agreed standard procedure for visual acuity testing. Below, some of the recommendations and points brought forward by the Visual Functions Committee of the International Council of Ophthalmology will be cited.

2.1 Definitions

The applicant's visual acuity is defined by the visual angle to the details of the smallest object that can be seen. In many European countries, a figure is derived from the actual test distance and the distance where the object is seen with a stroke width of 1 minute of arc. As an example, the figures 6/12 (or 20/40) are derived the following way: The subject is looking at objects at a distance of 6 metres (or 20 feet). The smallest object that he recognises would have been seen with a stroke width of 1 minute at the distance of 12 metres (or 40 feet); in fact they measure 2 minutes at the actual observing distance. The same figure, although usually written in decimal fractions, is obtained by calculating the inverse of the stroke width (in minutes) of the smallest object seen; 0.5 corresponds to 2 minutes etc.

6/6 or 1.0 is usually considered 'normal' visual acuity, although healthy young subjects often see 6/3 or 2.0. Charts limited to objects of 6/6 size deprive the examiner of the complete acuity testing.

2.2 Factors affecting the visual acuity

Among the factors that influence the outcome of the testing are the character of the test object (size and colour), the object contrast, the state of adaptation, the test distance, and the exposure time. With these held constant, acuity is limited by the refractive state of the eye and the capacity of the retinal-brain system.

2.3 Examination techniques

a *Test object*

Although tests with stripes, checkerboards and the like make possible a pure resolution task, their use is much restricted in practice. The Landolt ring (fig. 1), also predominantly testing the resolving power, has become the reference object to which others are usually compared. The ring has a stroke width and a gap measuring 1/5 of the outer diameter and is shown in different directions, usually the four main meridians. The several attempts to 'internationalise' this object have failed because testing is tedious and difficult to control in practice. The dominating optotypes used are letters, introduced by Snellen in 1862. Recognition of letters is a complex task, but their identification is probably a better means of measuring everyday seeing ability than any other test. Instruction is easy as is evaluation.

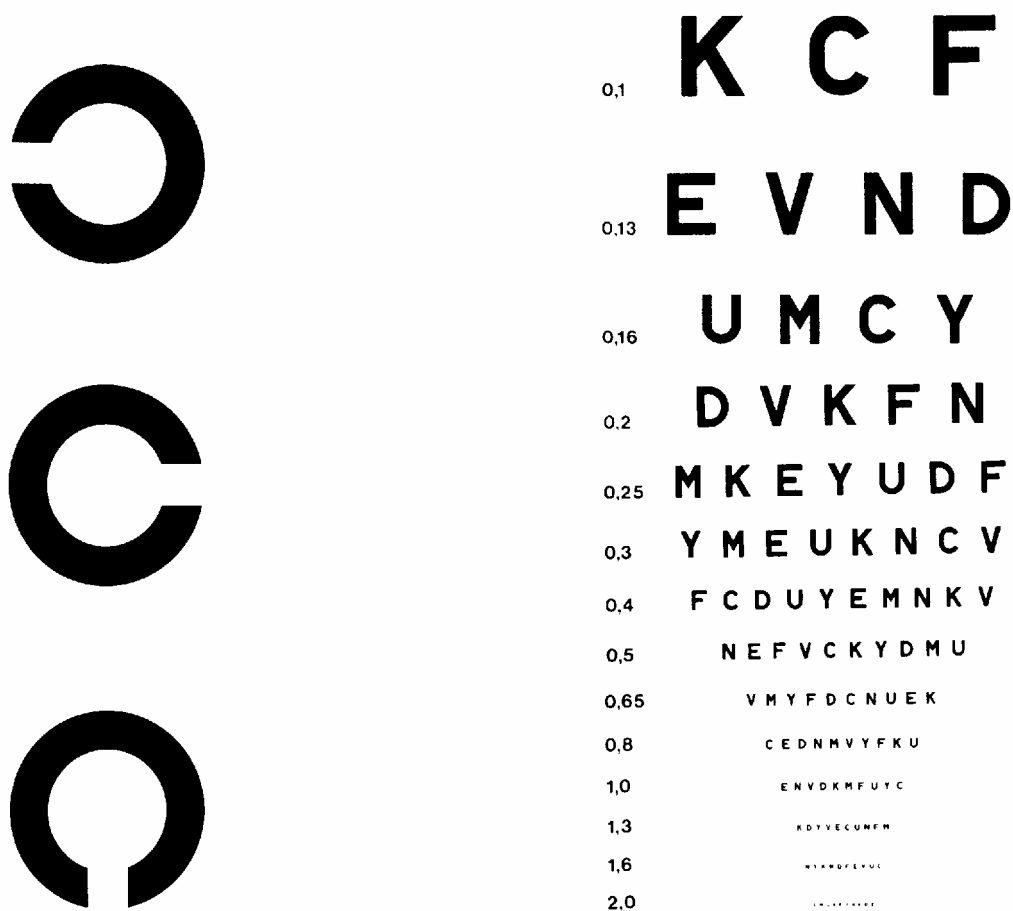

Figure 1 To the left Landolt rings; to the right a visual acuity chart with selected letters shown to be equivalent in legibility with the Landolt ring.

The main problem with letters is their different legibility. Some are easy to identify like L, I and T while others are difficult like G, R and B. A letter chart should include a selected number of letters of about the same legibility and equal to that of the Landolt ring. It is recommended that 10 different letters be used.

b Object contrast

Visual acuity decreases with reduced object contrast. A significant decrement does not occur, however, until the contrast decreases below 85%; the luminance of the black print therefore shall not exceed 15% of that of the white background. It is essential that no dirty or yellow charts be used. If a projector is used, it is essential that the object contrast is kept at optimal values.

Even very high levels of contrast may reduce the visual acuity.

c Illumination

The visual acuity increases with background luminance up to a maximum and then again decreases when the luminance is so high that glare interferes with seeing. As is evident in fig. 2, there are no significant differences as long as the luminance is kept above 80 cd/m².

All commercially available boxes with built-in illumination give a sufficient illumination. If, however, a chart is lit by an extraneous light source, it is important that this gives a proper illumination. It is easier to measure the light flux falling upon a surface (i.e. the illumination as measured in lux) than the luminance (i.e. the luminous intensity per unit area, usually measured in candelas per square metre, cd/m^2). Numerous other units for luminance exist, often creating confusion. With white paper reflecting about 75%, 1 lux roughly gives 0.24 cd/m^2 .

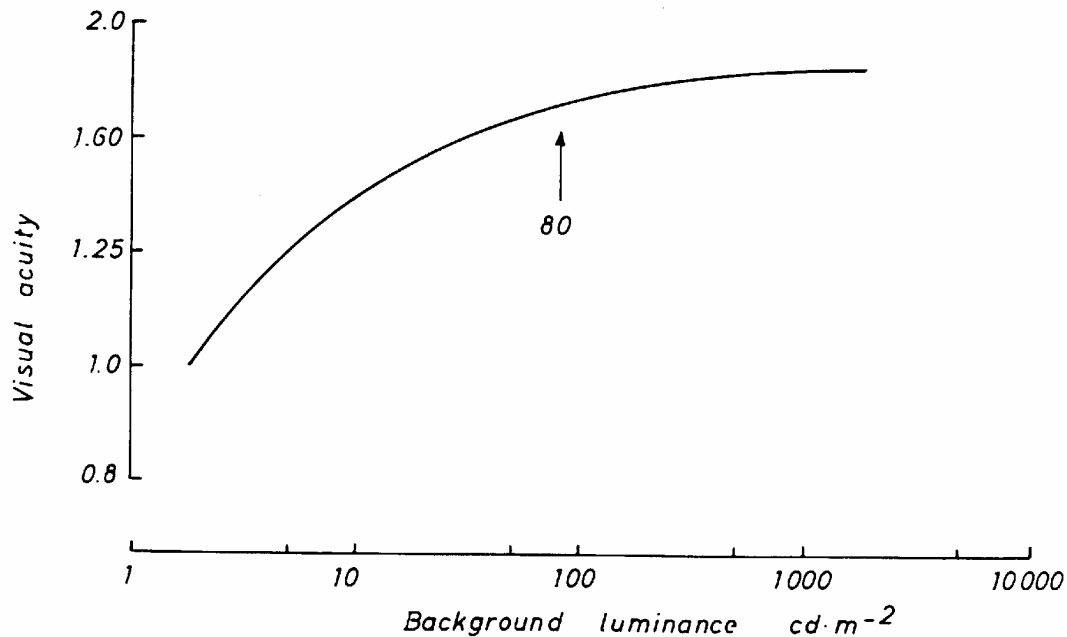

Figure 2 The relation between visual acuity and background luminance. The curve is compiled from several earlier and recent studies.

The illumination given by a 40 Watt desk lamp with a conical reflector at a distance of 1 metre gives a test chart luminance of about 28 cd/m^2 . The luminance changes with the square of the distance between the light source and the surface. In a well lit room, the chart luminance is also well over 100 cd/m^2 .

The area surrounding the test chart should have a luminance of not less than 20% of that of the chart. With ordinary charts, this demand is most easily accomplished when the walls are of light paint and the room light is on.

Thus, a standard office illumination will usually be adequate as background illumination. If visual charts are used, a chart illumination of 500 lux is required. Two standard 60 W bulbs mounted in ordinary office lamps will normally suffice.

The luminance of the test field and its surroundings also influences the diameter of the pupil. Aberrations reduce the acuity when the pupil is larger than about 5 mm. Small pupils act like stenopaic discs whereby optical faults are masked. When smaller than 2 mm, diffraction in the pupil again reduces the acuity.

d *Test distance*

Visual acuity should from a theoretical point of view be assessed at infinity, but has usually been measured at a distance of 5 or 6 metres (or the equivalent in feet), being the distance closest to infinity practicable under usual circumstances. Mirror readings may be used to

obtain the correct measuring distance. From the point of physiological optics, visual acuity values obtained at various distances are equivalent, although departures from the correct distance interfere with the correct measurement. The closer the distance the more pronounced the error. Acuity testing at near, e.g. 40 cm, gives no additional information except in certain pathological cases.

e *Exposure time*

As long as the object is exposed longer than a few tenths of a second, visual acuity is not influenced by the exposure time. In practice, this factor is of no importance.

f *Practical acuity testing*

For the testing of aviation personnel, Landolt rings or letters proven to be equivalent with these should be used. The Landolt rings should be shown in the four main meridians.

A chart may have just those object sizes which correspond to the limit values of the various visual requirements. Usually, however, ordinary clinical charts are used. These should preferably show rows where the object sizes increase geometrically; the recommended size increment is $1.26 (= \sqrt[3]{2})$.

Of each size should be shown 5–10 different letters or Landolt rings.

In examinations of aviation personnel, no error is allowed.

Charts with a matt surface and high contrast should be used. The illumination should be checked to concur with the luminance demands. If projectors are used, the slides should be clean and the screen of high reflectance. The ambient illumination should be so adjusted that both the object contrast and the state of adaptation are as high as possible.

2.4 **Reduced vision in one eye**

There are relatively frequent cases of applicants whose vision is reduced but where the visual acuity is still within the Visual Requirements. Reduced visual acuity may be caused by refractive errors, slight amblyopia or organic eye disease. Before such a reduced visual ability is accepted and the applicant assessed as fit, the pathogenesis of the reduced visual acuity should be assessed and taken into consideration.

2.5 **Visual functions related to visual acuity**

a *Mesopic resolution*

Under certain circumstances, especially when the ambient illumination corresponds to a mesopic state of adaptation, the ability to identify/resolve objects of low contrast is of importance. Apparatuses and charts for this purpose have been constructed. Unfortunately, knowledge of the normal capacity is so far limited and standards have not been agreed upon.

b *Contrast sensitivity function*

As mentioned above, best visual acuity is obtained with high contrast objects. With low-contrast objects, the acuity is reduced. The relation between object contrast and resolving power is called the contrast sensitivity function. Correlations have been demonstrated between the contrast sensitivity and the visual performance in simulated flying.

Contrast sensitivity and visual acuity are two separate functions with each its own neurophysiological pathway. There is no doubt that the contrast sensitivity function tells us much more about the visual capacity of the subject than the (high contrast, high frequency) visual acuity alone (fig 3). An examination for contrast sensitivity could reveal abnormalities not shown by other tests. For air force pilots, a superior detection capacity certainly can be of relevance.

In civil aviation, however, this examination still has to be validated. Furthermore, although norms for a 'normal' population are at hand, we do not know which results should be considered disqualifying for aviation personnel. Further data are needed in order that this examination be included in the vision test battery for routine purposes.

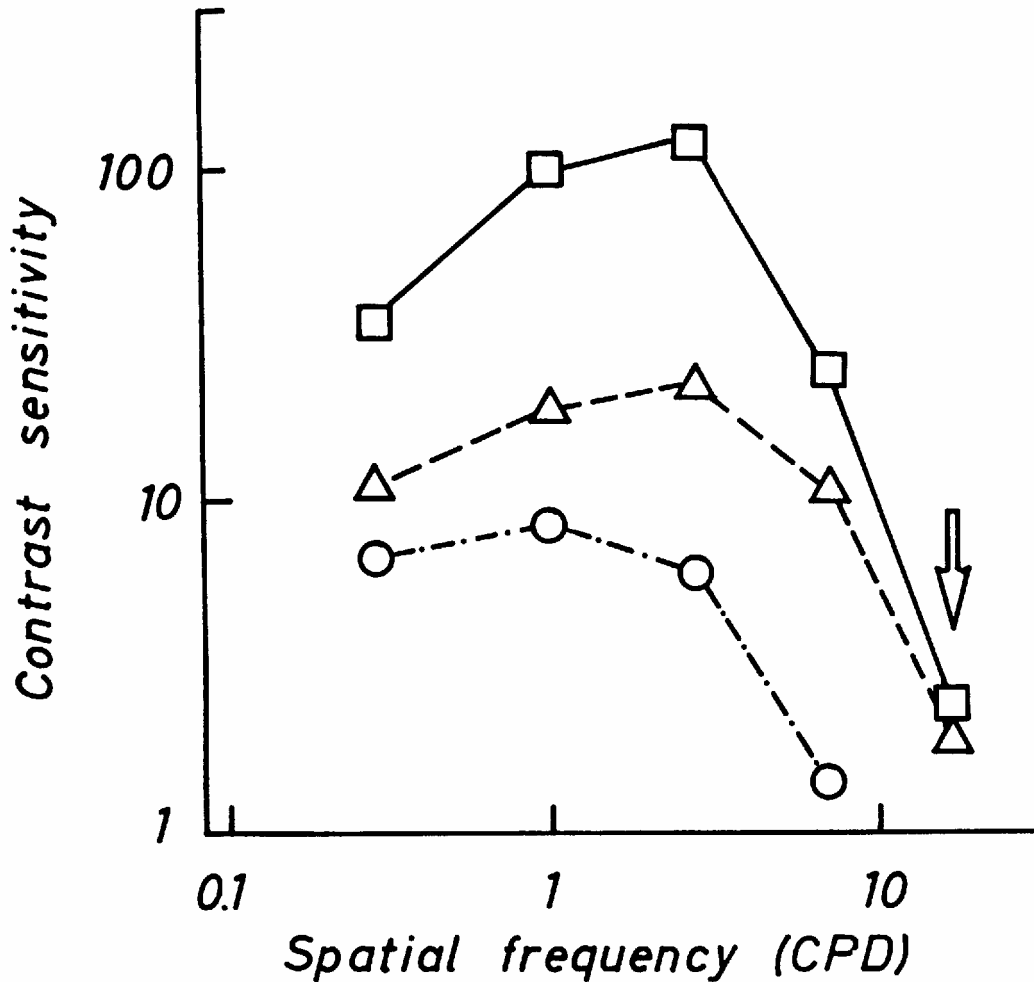

Figure 3 Typical results of contrast sensitivity testing; this is measured for different spatial frequencies of the test objects (in cycles per degree). The uppermost curve (solid, squares) shows the typical intermediate maximum. The middle curve (dashed, triangles) is an example of impaired sensitivity for lower frequencies that will *not* be revealed by visual acuity testing (high frequency, arrow). The lower curve (dash-dots, circles) shows reduced frequency for all frequencies; this will be evident by reduced visual acuity.

c *Dynamic visual functions*

In road traffic, some dynamic visual functions have been shown to be of high validity for the driving capacity. Correlations between a visual function and performance are difficult to prove/disprove for car drivers, and this should be even more so for air crew due to the very limited number of accidents. It is highly plausible, however, that the constant motion of objects in the visual scene of pilots gives these factors a high relevance.

The dynamic visual acuity is the resolving power for moving objects. This capacity decreases with the angular speed of the object and the decrement is more outspoken with increasing age. The threshold of angular movement defines the ability to observe lateral movement and the threshold of angular subtense defines the ability to see whether an object is coming closer or recedes. These latter have great significance when it comes to the analysis of movements of for example other aircraft. Standards for these functions are not available so far.

d *The relationship between refractive error and uncorrected visual acuity*

With increasing myopia (or hyperopia without accommodation), the visual acuity decreases. In several studies, one has tried to establish the relationship but the results have been contradictory. Some studies have shown a correlation between the amount of ametropia and the logarithm of the visual acuity. If this be true, a certain degree of myopia would correspond to a certain number of rows on a geometric visual acuity chart. In other studies, a linear relation between the ametropia and the visual acuity has been found. Roughly we will expect an uncorrected visual acuity of 6/12 for -1.0 dioptre and 6/60 for -2.5 dioptries of myopia.

3 NEAR VISION AND ACCOMMODATION

3.1 Printed text

As stated above, no additional information about the resolving power of the visual system is gained by testing the ability to identify single objects at close range (one exception is when a nystagmus is blocked by convergence). Additional information is, on the other hand, given by the ability to read printed text – a task of high relevance to aviation personnel.

The ability to read printed text depends upon the resolving power of the visual system but also highly on complex cognitive factors. There is, therefore, no direct correlation between (distant or near) visual acuity and the reading capacity and the latter is not equivalent to 'near visual acuity'.

In order to measure the reading capacity, the Jaeger text types were constructed. These were never standardized, however, and texts with the same number vary greatly in different editions. No international agreement exists for reading texts. Those that best fulfil modern demands are the British N-types (as adopted by the British Faculty of Ophthalmologists), see fig. 4. Here, the print chosen is 'Times Roman', the most common print in books and papers. Sizes are designated by typographical point numbers. These are based on the height of the body or block of metal which carries the letter and are not the measure of the face. In various countries, the same Times Roman point numbers correspond to slightly different letter sizes. These differences are, however, so small that they are unimportant in practice. If N-types or equivalent texts are not available, other texts can be used. Examples are the Parinaud and the Birkhäuser reading texts. Corresponding legibility is given by texts with a lower-case letter height of 0.9 mm (N 5) and 2.2–2.4 mm (N 14).

NEAR VISION ACUITY

SLOAN LETTERS

This chart should be held 16 inches (40cm) from the eyes, at right angles to the line of vision, and illuminated with not less than 10 or more than 25 foot candles of light. [108-269 lux]

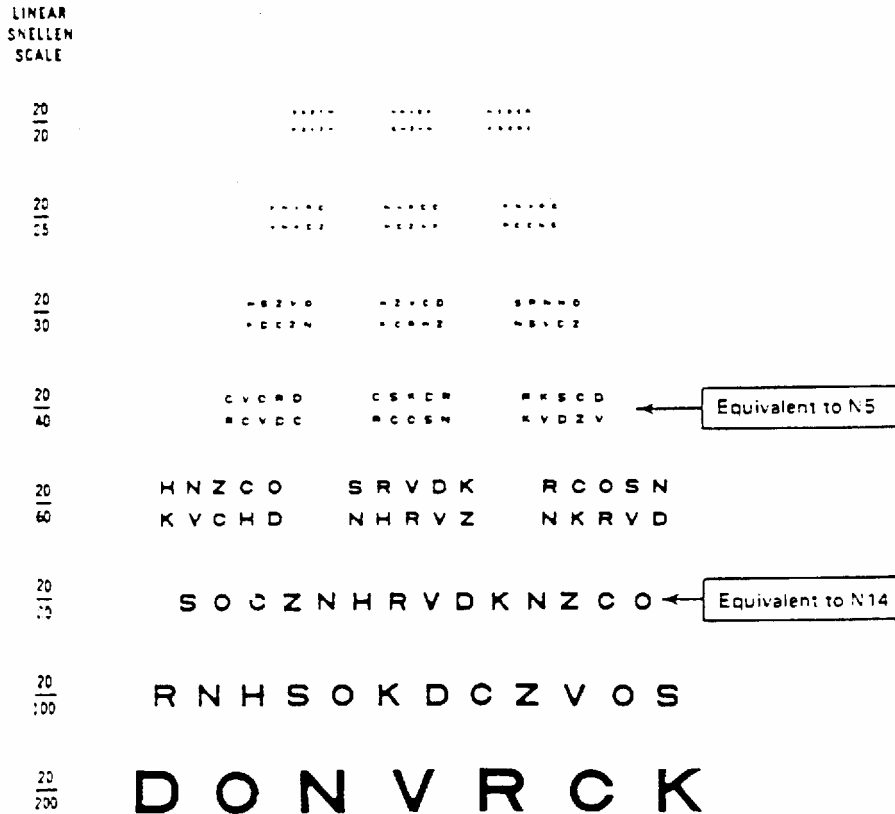

AERONAUTICAL CHART READING

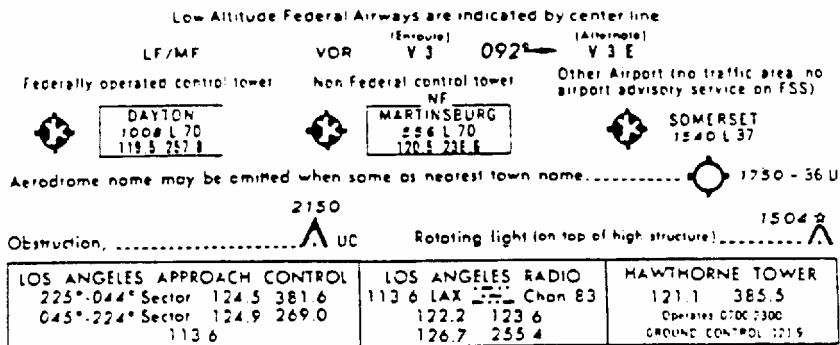

Figure 5 Example of a near vision test provided with aeronautical symbols. Observe that this chart tests near acuity and not reading capacity.

3.2 Examination techniques

Near visual capacity should be determined and recorded both with and without correcting lenses. The N-type near vision charts or equivalent should be used (fig 3). The examination should be conducted in a well-lit room with an illumination of the test chart of at least 50 lux.

The applicant should hold the N5 chart at a distance selected by him and appropriate to his regular tasks within the range 30–50 cm (12–20 inches). The N14 chart should be read at a distance of 100 cm (40 inches); this distance may be checked by a string.

The near vision is recorded as the distance at which the applicant can read the N5 chart and by stating whether the N14 chart is read at 100 cm or not.

3.3 Accommodation

When one focuses on an object at a finite distance, the refractive power of the eye has to be increased by accommodation. This is accomplished through contraction of the ciliary muscle and an increased curvature of the lens.

In order to measure this capacity – the range of accommodation (difference, measured in dioptres, between the refractive powers of the eye at maximal accommodation and maximal relaxation) and the near point of accommodation (focal distance, measured in centimetres, at maximal accommodation) are established. This is done with the aid of an object that is moved progressively towards the eye until it just becomes blurred. Alternatively, the object is moved, starting close to the nose, away from the eyes until it is just seen – a method claimed to give more consistent results. In any case, fine print and a rule (special rules are available, the RAF Near-Point-Rule is particularly handy to use) adequately serve the purpose. The applicant shall put maximum effort into the test. The distance from infinity to the near point defines the range of accommodation and can be expressed in distance units or (usually) in dioptres.

With increasing age the accommodative range decreases due to reduced elasticity of the lens (fig. 6). It is nil at an age of about 60 years, but seemingly some accommodative power is left because of the depth of focus of the eye. Also the speed of accommodation is reduced with increased age.

INTENTIONALLY LEFT BLANK

Age	Diopters	Near-point (cm)
16	12.1	8.2
18	11.7	8.5
20	11.3	8.8
22	10.8	9.3
24	10.3	9.7
26	9.8	10.2
28	9.3	10.8
30	8.8	11.4
32	8.3	12.0
34	7.7	13.0
36	7.1	14.1
38	6.5	15.4
40	5.8	17.2
42	5.0	20.0
44	4.3	23.3
46	3.4	29.4
48	2.5	40.0
50	1.8	55.6
52	1.6	62.5
54	1.4	71.4
56	1.3	76.9
60	1.2	83.3
65	1.1	90.9
70	1.0	100.0

Table I Near-point variation by age

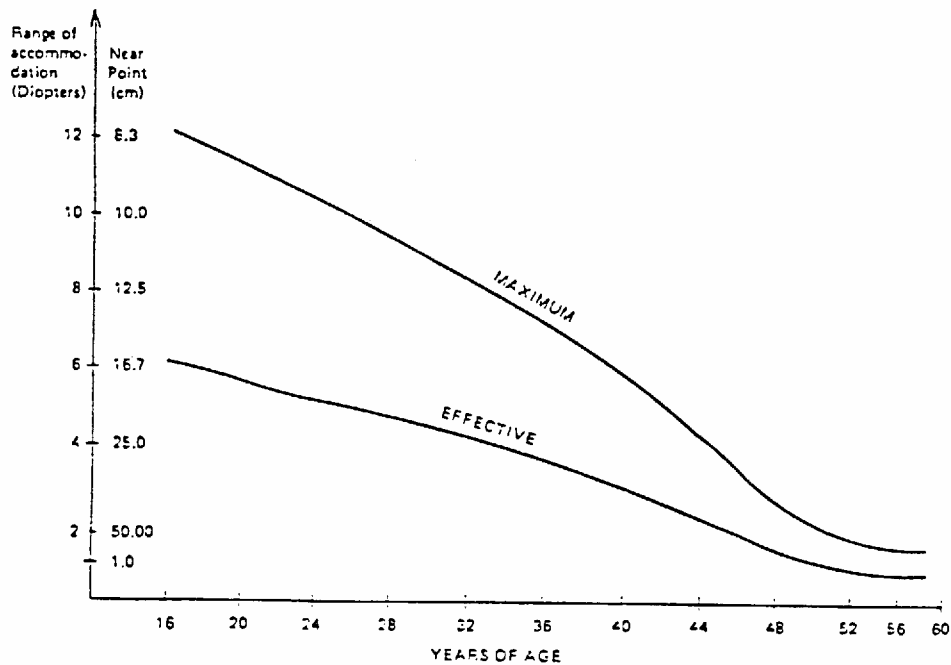

Figure 6 Maximum and effective accommodative range

The term presbyopia is used when the accommodative power, applied without effort, is insufficient for near vision. An emmetropic subject generally first notices the problems at an age of 40–45 years. The hypermetropic subject has to use part of his accommodative power to compensate for the refractive error

and becomes presbyopic at an earlier age. In myopia, the accommodative range is displaced towards the eyes, and presbyopia is thereby retarded (fig. 7).

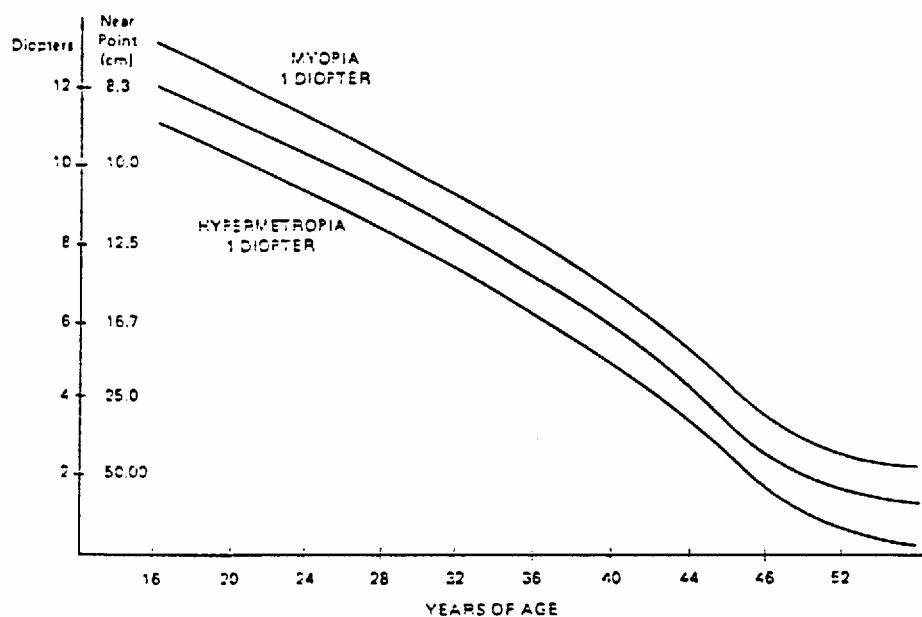

Figure 7 Change of near point by pre-existing ametropia

The near-point is measured with maximum accommodative effort. Comfortable sustained looking is not possible so close to the eyes, and presbyopia is therefore corrected so that there is a reserve power of accommodation. Often the term 'effective accommodation' is used to describe the amount of accommodative effort which can be used regularly without causing asthenopia. A practical rule to prevent asthenopia induced by accommodation is to prescribe reading glasses when the working distance is no longer easily matched by the effective accommodation.

The amount of accommodative effort required for a certain task depends on the luminance of the object looked upon (illumination and reflection) and of object contrast. Under mesopic conditions and with low-contrast objects, a stronger than normal presbyopic correction may be necessary.

When the near-point of accommodation exceeds 33 cms (or the accommodative range falls below 3 dioptries), near correction should usually be prescribed.

a *Fatigue of accommodation*

Abnormally high accommodative effort causes a condition characterised by blurring of vision, headache or a burning sensation in the eyes. The principle reason for these problems is presbyopia which is accentuated by physical fatigue. It may, however, be induced or accentuated by other causes as well. Disorders of general health status may transiently reduce the effective power of accommodation, e.g. mental stress, oxygen deficiency, and G-forces. Neurological diseases or intoxications may affect the III nerve or ciliary muscle function. Some drugs likewise reduce the accommodative range, e.g. some tranquilizers and drugs for treatment of hypertension or atropine-like substances for treatment of disorders of the digestive tract. Further causes are eye diseases and cycloplegic drops.

Any of these causes may call for an earlier or stronger than normal presbyopic correction.

b *Eye strain – Asthenopia*

Fatigue of accommodation is only one cause for a condition characterised by a feeling of tiredness in the eyes, intermittent blurring of vision and headache mostly localised in and around the eyes. This condition is called eye strain or asthenopia. General fatigue is often manifested as eye strain. Disorders of the outer eye, like conjunctivitis and blepharitis may induce eye strain. The two most common causes are faulty correction of refractive errors and muscular imbalance. Correction by spectacles or lenses must not only be based on the refraction of the individual eye but also on the tolerance of anisometropic differences. Latent or manifest squint imposes extra demands on the extraocular muscles and can thereby induce asthenopia. A practical rule to prevent asthenopia caused by fatigue of accommodation in presbyopic pilots is to use only half of the existing maximum accommodative capacity and prescribe reading glasses for the rest of the necessary accommodative range.

4 REFRACTION

The refractive state of the eye applies to the condition when the accommodation is completely relaxed. Induced relaxation with cycloplegic drops is necessary for retinoscopy and when, in subjective refraction, an accommodative spasm is suspected.

In emmetropia, rays of light from infinity are focused on the retina. This is a relatively uncommon condition.

Ametropia is any deviation from emmetropia; there are three basic types: hypermetropia (hyperopia), myopia, and astigmatism. Ametropia is measured in dioptres. The limits of refractive error as stated in the Visual Requirements are based on measurements with the optical centre of the spectacles placed 12 mm from the cornea.

4.1 Refractive errors

a *Hypermetropia*

A hypermetropic eye is deficient in refractive power; it is absolutely or relatively too short (fig. 8). Thereby light from infinity is focused on a point behind the retina. Hypermetropia is a synonym of the colloquial term farsightedness which is often confused with presbyopia, a condition caused by a decrease of accommodative power with age.

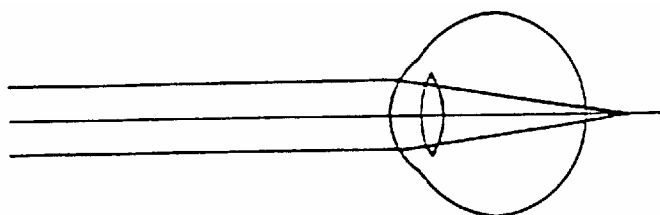

Figure 8a In the not accommodating eye, rays from distant objects are focused behind the retina.

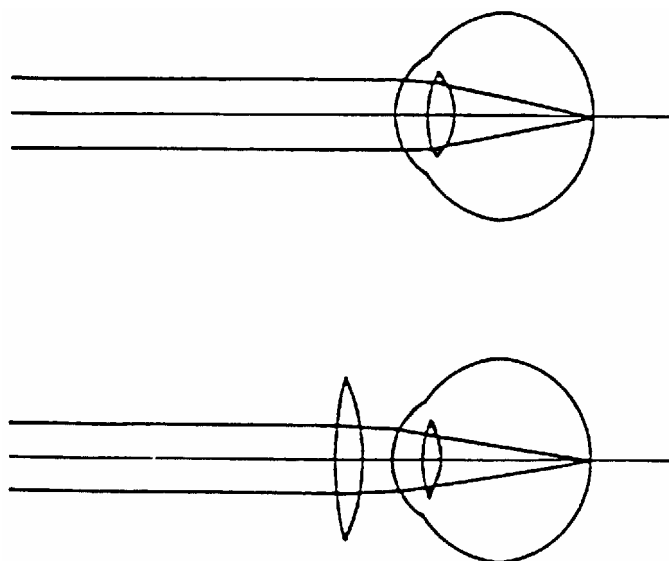

Figure 8b To compensate for this accommodation in the non-presbyopic eye (upper), a convex lens (lower picture) could be used.

Hypermetropia is corrected with a convex, plus or positive lens. Hypermetropia can also be compensated for by accommodation. In the young person, this is recognised as manifest hypermetropia. Cycloplegic refraction will enable the examiner to assess the degree of hypermetropia in Class 1 applicants. A specific manifest hypermetropia screening test is not indicated for Class 2 applicants because the hypermetropic refractive error limit is +5 dioptres. However, Class 2 applicants under the age of 25 will require cycloplegic refraction if their spectacle prescription is greater than +3 dioptres as the prescription may not actually reflect the degree of hypermetropia present. With increasing age, the accommodative range is reduced and at a certain age the subject needs plus correction for sharp distant vision. He also needs reading glasses earlier than emmetropic persons.

A slight or moderate degree of hypermetropia needs no correction in young persons. Higher degrees of hypermetropia demand a constant accommodation which can give rise to eyestrain. Due to the association between accommodation and convergence, it also induces a tendency to latent squint inwards (esophoria) or a proper squint in subjects with a weak fusion lock (esotropia).

b *Myopia*

In myopia, light rays from infinity are focused in front of the retina (fig. 9) due to increased refractive power of the eye or a lengthening of the eye globe. Distant objects are blurred, even more so with accommodation. The degree of myopia corresponds to the most remote point sharply focused. Myopia is corrected with concave, minus or negative lenses. In order to unveil minor myopias, it is essential to use acuity charts with sufficiently small objects, i.e. corresponding to an acuity of 1.6 or 2.0.

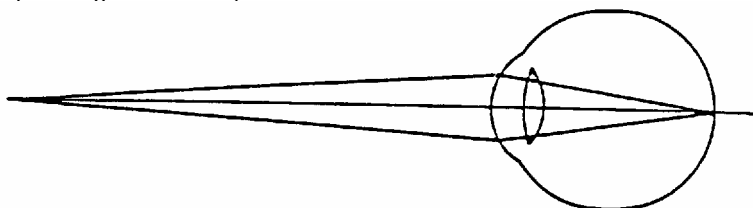

Figure 9a In the myopic eye, there is a far point beyond which objects are imaged sharply.

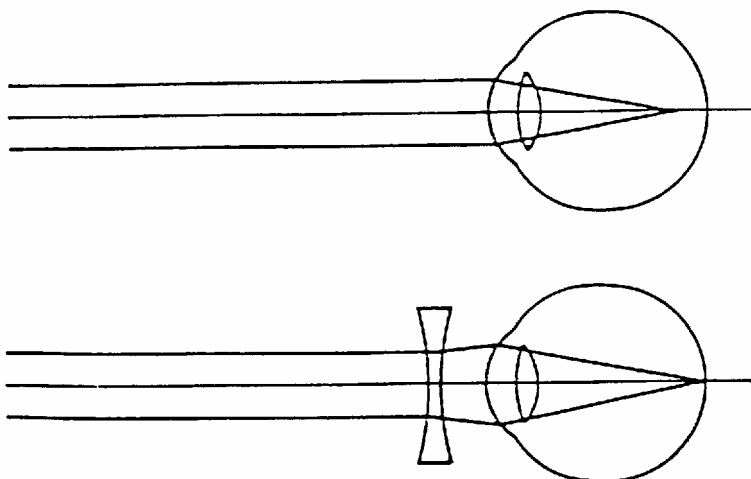

Figure 9b In the myopic eye, distant objects are focused in front of the retina (upper). Correction is only possible with a concave lens (lower picture).

c *Astigmatism*

In astigmatism, the light rays of different meridians are not equally refracted (fig. 10). Regardless of the degree of accommodation, a sharp focus cannot be attained and both distant and near objects are blurred. The reason for astigmatism can be abnormal corneal curvature or lens asymmetry.

In regular astigmatism, the refractive error can be corrected by a cylinder lens. Most commonly, the axes are located in the principal meridians, i.e. at 90° and 180°.

All possible combinations with hypermetropia, emmetropia and myopia exist. To a plus or minus cylinder may have to be added a plus sphere, a plano glass, or a minus sphere for sharp imaging of distant objects.

Irregular astigmatism is caused by an irregular corneal curvature due to trauma, inflammation, scars or degeneration. Usually, this refractive error can only partly be corrected by a cylinder lens but may, if not too large, be completely eliminated by a hard contact lens.

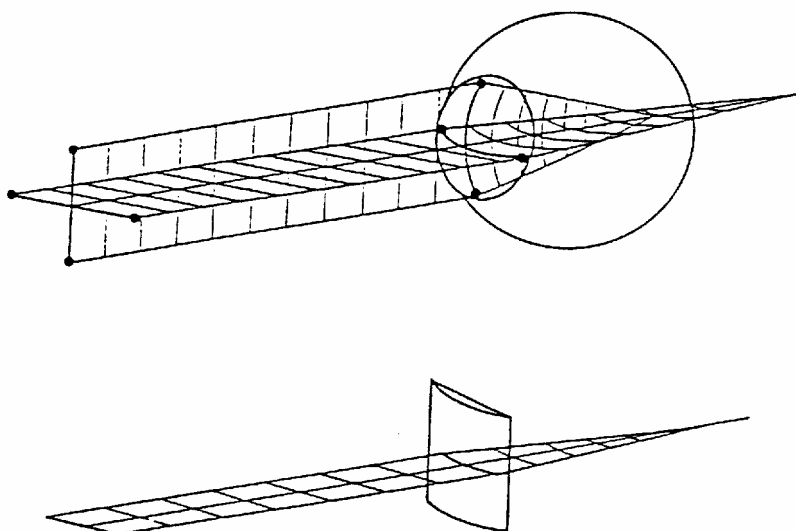

Figure 10 In the astigmatic eye, the refractive power differs in different meridians. To correct this type of error a toric or cylindrical lens must be used, often in combination with a spherical convex or concave lens.

d *Stability of refraction*

It is important that the examining ophthalmologist also evaluates the stability of the refractive error.

If the ophthalmological history or the clinical examination indicates a progressive refractive error likely to exceed the limits in the future, the applicant should be assessed as unfit. Re-evaluation may be performed after one year and after licensing the ophthalmological examinations should be repeated at individual intervals until the refractive error is deemed to be quite stable.

In case of myopia beyond -3.0 dioptres, other tests may be necessary to rule out a retinal disorder. The risk of chorio-retinal degeneration and retinal detachment rapidly increases if the myopia exceeds $5-6$ dioptres.

4.2 Measurements of refraction

Refraction is performed in order to determine the nature and degree of the (possible) refractive errors of the eye. In subjective methods, the applicant has to cooperate by telling which lens combination gives the best vision. Objectively, the refraction can be measured by retinoscopy or with the aid of manual or automatic refractometers. To save time and effort, refractometer data can be used when making the final subjective refraction. Cycloplegia may be necessary to establish the degree of refractive error correctly, especially in cases of moderate hypermetropia.

4.3 Spectacle correction of ametropia

In the Visual Requirements JAR–FCL 3.220 the maximum acceptable refractive error is stated to be ± 3 dioptres. One of the reasons for setting an upper limit is the optical aberrations caused by correcting lenses. These optical errors increase with increasing lens power and towards the edge of the lens. With modern materials used in high-quality correcting glasses problems are most unlikely to occur inside the range of ± 5.0 dioptres.

Distortion of the image due to peripheral angular magnification narrows the effective visual field.

The prismatic deviation gives rise to double vision in myopes and a ring scotoma in hyperopes.

In anisometropia, the refractive state is different in the two eyes. When corrected with glasses, these give a dissimilar magnification – a condition known as aniseikonia. The illusion created is particularly disturbing during the initial stages of wearing anisometropic spectacles; it is better tolerated when the glasses are prescribed at a young age. As a general rule, an anisometropia of 3 dioptres can be tolerated; if problems arise, a special evaluation as to the practical applicability is necessary.

5 VISUAL AIDS

For distance visual tasks, distance optical correction may be necessary, as discussed further later. The distance to the intermediate objects, i.e. instruments, is shown for some typical aircraft in Table II. These have been measured from the position of a 'reference eye' and small differences between pilots can occur depending on the individual seating position. It is evident that there are some variations between different aircraft and distances typically range between 40 and 120 cm, corresponding to an accommodation or correction of $2.5-0.8$ dioptres. Printed material is read at a

still closer distance, typically 33–40 cms (2.5–3 dioptres). Among pilots there is some variation in reading habits, i.e. the distance chosen for comfortable reading.

Table II Flight deck visual distances
Sample reading distances measured for individual pilots

<i>Aircraft</i>	<i>Reading distances (cm)</i>			<i>Mean in diopters</i>
	<i>Closest</i>	<i>Furthest</i>	<i>Mean</i>	
DC8				
Instrument approach and landing chart	40	53	45	2.2
Artificial horizon	66	73	71	1.4
Overhead instruments	45	53	48	2.1
DC9				
Instrument approach and landing chart	37	51	44	2.3
Artificial horizon	65	80	80	1.4
Overhead instruments	38	59	47	2.1

Correction lenses for aviation personnel, when necessary, can be predicted by simple arithmetic if the following facts are known:

- 1 the subject's refraction and accommodative range,
- 2 the distance to the intermediate tasks,
- 3 the preferred reading distance.

Further points of relevance are the actual size of dials, pointers, figures, and text. If these are particularly small, the subject must use a shorter viewing distance in order to increase image size. This is also necessary when the general illumination level or the object contrast is low.

The following example illustrates the necessary calculations. If an emmetropic subject has to view an instrument at a distance of 50 cm (0.5 m), he has to accommodate $1/0.5 = 2$ dioptres. If the subject is also 0.5 dioptre hypermetropic, one must add these 0.5 which gives 2.5 dioptres. If the instrument is seen in red illumination, one may have to add another 0.25 dioptre of chromatic aberration. This accommodative effort is no problem to a young person. A person of intermediate age may need a correction of +1 to +1.5 dioptres to aid accommodation, but one over 60 years of age must wear the full correction, i.e. +2.5 to +2.75 dioptres.

When correcting lenses are needed for meeting the Visual Requirement, one set of spectacles only should cover the need of distant as well as near correction. A spare set of identical spectacles should be immediately available during flight. In pilots whose uncorrected visual acuity falls below the standard, spectacles should be constructed so as to minimise the risk of being lost during flight.

5.1 Spectacles for aircrew

The aim of prescription of glasses is to give the subject a good and comfortable vision. The fact that the person has a refractive error does not necessarily indicate a need for spectacles. Many people have some refractive error, often a minor hypermetropia or astigmatism, that gives rise to no troubles at all. It is common experience that spectacles prescribed for these aberrations are not worn. In aviation, a prescription for glasses is needed when a substandard visual acuity is found or in cases where visual fatigue, muscular imbalance or increased glare sensitivity could be explained by an error of refraction.

It has been claimed that air crew are reluctant to use glasses because their use seems to indicate that 'something is wrong with their eyes'. Even if this be the case, it should still be possible to motivate the applicant if the examination shows that either distance or near vision is significantly improved by lenses. The most common need, i.e. the beginning need for presbyopic correction can be demonstrated further by simulating the ordinary working condition: low ambient illumination, small print, etc.

When glasses are prescribed, it should be remembered that their comfortable use depends on a proper fit of the correcting lenses. The axis of a cylinder lens must correspond to the subject's astigmatism and the optical centre of the lens to the visual axis of the eye. Decentration is annoying mainly due to the prismatic effect which is larger when the lens power is high. In these cases it is also important that the distance between eye and lens is correct because deviations give rise to changes in effective lens power.

If glasses are prescribed, it should be recommended that their frames are so constructed that they do not interfere unnecessarily with the visual field. In the case of hypermetropia, a thick frame around the glasses adds to the ring scotoma created by the lens. In the case of myopia, this effect may be beneficial because of the double vision of corrected myopes. The spectacle arms should be thin and placed above or below the level of the eyes; it has been recommended that they should not be wider than 6 mm.

Myopia should always be corrected when it interferes with sharp distant vision. It should be remembered that the myopic refractive error may successively increase up to the age of 25–30 years.

Hypermetropia should be corrected when it causes impaired distant vision, gives rise to eye-strain, or interferes with the muscular balance. The constant accommodation of an uncorrected hypermetropic subject is not always immediately released by a positive lens. Therefore, correction often has to be successively increased.

Astigmatism should be corrected when it causes reduced visual acuity and/or gives rise to eye-strain. An astigmatic correction should be worn all the time. It can be severely disturbing to wear an astigmatic correction when looking only at distance or near.

Presbyopia is usually corrected when the effective range of accommodation is lower than 3–4 dioptres. This means that uncorrected hypermetropes, who use part of their accommodation for sharp distant vision, have to be corrected earlier than emmetropes. When a presbyopic aid should be started, its proper strength can be deduced from the refractive state, the location of the accommodative near point, and the reading capacity of the subject.

Pilots and air traffic controllers have to change their gaze frequently between objects at near, intermediate and long distances. This calls for a correction that enables sharp focusing at several distances. It is stated that the applicant who only meets the requirements for near vision with correction must have the glasses 'available for immediate use', but there is in practice no time to put glasses on and off. The subject who does not need distance correction can preferably use 'look-over' glasses. Those who normally wear distance correction must have a segment for intermediate/near vision ground into the lower part of the spectacle lenses. Such bifocal glasses enable sharp distance vision through the larger upper part of the lens and sharp near vision through the lower segment. The size and location of this lower segment can vary; three common types are shown in fig. 11.

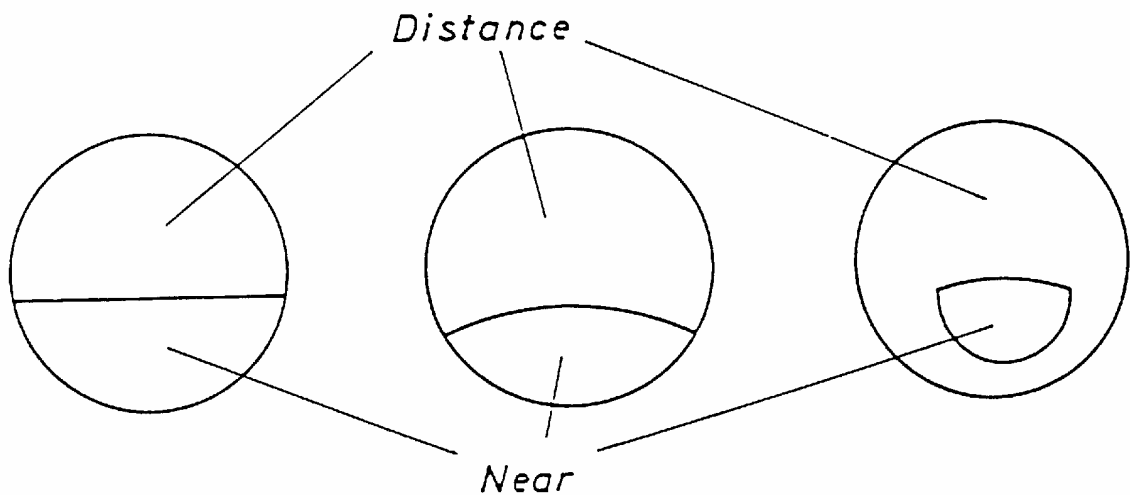

Figure 11 Three examples of bifocal lenses.

An even more sophisticated type of lens is the trifocal lens. Here, a third segment for intermediate vision is placed between the upper distance part and the lower near part. Such lenses must be carefully designed to suit the needs of the pilot. The intermediate segment should cover the instrument panel and pedestal without interfering with vision through the other two parts. Some people have difficulties in getting accustomed to the use of these lenses and most senior pilots prefer the ordinary bifocal glasses.

There are also glasses with a continuous increase in power from the upper to the lower part of the lens. These progressive glasses enable the selection of proper focusing by tilting of the head. The earlier generation of these glasses created an annoying and possibly dangerous distortion to the right and left of the central zone. These distortions are much reduced in the current lenses. Some people are enthusiastic wearers of these lenses while others claim that they prefer ordinary bifocal or trifocal lenses. Whether they will be accepted by the individual subject cannot be foreseen; today, however, there is no reason to condemn their use by air crew.

There is a special problem valid for the presbyopic pilot who has to focus intermediate objects in the upper part of the spectacle lenses, i.e. overhead instruments. As long as the accommodative power is at least 2 dioptres, sharp vision is possible without correction or through the distance correction. The senior pilot, on the other hand, may need a correction for intermediate vision ground into the uppermost part of the lenses, a special type of trifocal lenses (fig. 12).

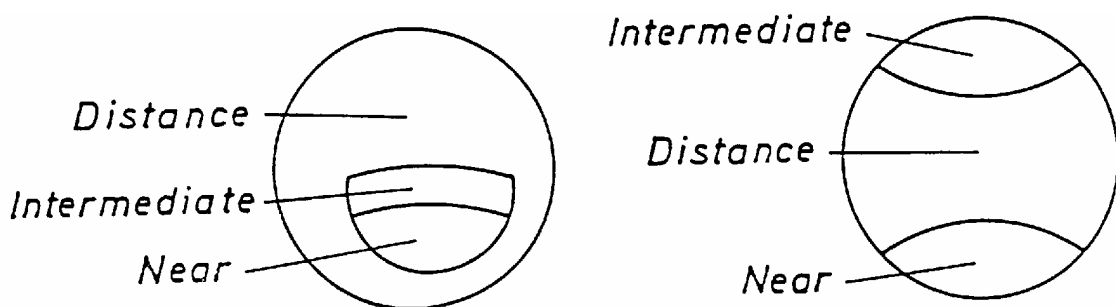

Figure 12 To the left an example of a conventional trifocal spectacle lens. To the right a trifocal lens especially made for pilots.

There are even more sophisticated lenses with four or five segments and there are progressive lenses with a segment for near vision in the upper part. Another solution to the problem is the 'flip-type' glasses (fig. 13). The fix lenses are ground for distance (above) and intermediate vision (below). The moveable lenses add a plus correction on both thereby transferring the glasses to intermediate and near vision respectively. Any combination of lens powers is possible, and the flipping up and down can be done so fast that the shift is no hindrance to operational activities.

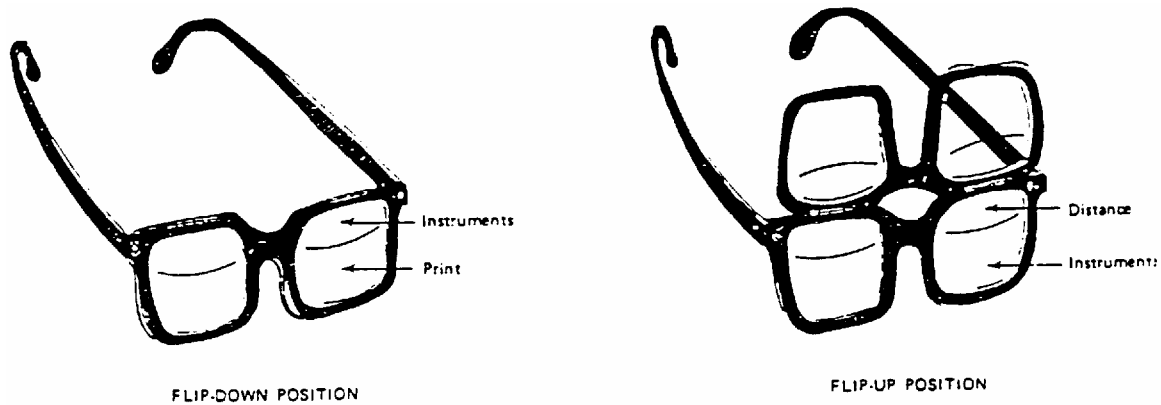

Figure 13 Examples of flip-type frames suitable for aviation duties.

What kind of prescription that should be selected has to be discussed in detail with the individual pilot. Most senior pilots are satisfied with look-overs or ordinary bifocals. If this is not the case, one of the other possibilities should be considered.

It is important that the size and position of the segments for intermediate and near vision be individually determined. The pilot can aid in determining this by marking an old pair of glasses while sitting in his ordinary cockpit position and shifting gaze as during normal operation of the aircraft.

The examiner should also be aware of the licensing requirements specifying that a spare set of corrective lenses should be available to the air crew member who fulfils the visual requirements only with correction.

5.2 Sunglasses

Sunglasses are a desirable and often necessary piece of protective equipment. They reduce the luminous flux entering the eye and therefore improve vision under conditions with large areas of high luminance in the visual field. They may prove particularly useful in flight over clouds. Sunglasses should be neutrally tinted (i.e. shades of grey only) in order not to interfere with colour perception. Polaroid sunglasses can cause problems when used in cockpits with laminated windscreens.

The so-called photo-chromatic lenses darken when exposed to ultraviolet radiation; their transmission therefore varies with the daylight level. Today's second generation of photochromatic lenses transmits maximally 90% when completely bleached; maximum absorbance varies between 45% and 70%. Glass temperature markedly influences the degree of tinting: high temperatures reduce the degree of darkening and increase bleaching speed. Most of the outdoor UV radiation is filtered out by cockpit windows and also the effect of sunlight on these glasses is reduced by the limited window sizes. Furthermore, the ambient temperature sets a limit to the tinting.

Photo-chromatic lenses darken and bleach according to rather slow exponential curves. It takes several minutes until a sizeable darkening is achieved and about 15 minutes to maximum

absorbance. Full bleaching is attained first after about 30 minutes although more than half of the absorption is lost after about 5 minutes.

The pilot who finds their function satisfying can use photo-chromatic glasses provided that they are of the type that gives a small light absorbance under night-time conditions. But generally the use of these glasses should be discouraged. When descending through clouds the glasses react far too slowly, and the pilot who needs a refractive correction must always have an additional pair of non-tinted glasses available.

5.3 Contact lenses

Contact lenses provide significant optical advantages compared to spectacles, especially to those who demand a high-power correction. The latest decade has seen a continuously increasing use of contact lenses and the production of several new lens types. They have different characteristics and the individual acceptance varies with the lens type. For use by aircraft personnel, some types are better suited than others.

a *Advantages of contact lenses*

The main advantage of contact lenses over spectacle glasses is their superior geometrical optical characteristics. Since the contact lens is placed on the corneal surface, the distortion and change in image size created by the correction is minimal. The Visual Requirements, however, normally limit the size of ametropia accepted and these differences are not very significant with lens powers <5 dioptres. With contact lenses, there are no spectacle frame scotomas. Fogging of the lenses, which occurs when the ambient temperature is suddenly increased, is also eliminated. It is further more convenient to wear contact lenses than glasses under a helmet, mask or the like.

Hard (or stable) contact lenses offer a significant advantage over spectacle lenses in cases of corneal astigmatism; with these the anterior refractive surface of the eye is corrected from uneven to even. In cases of irregular astigmatism, these lenses may be the only means of attaining sharp imaging.

In cases of high degree of anisometropia (inter-ocular refractive power difference), contact lenses may offer the only possibility of attaining undisturbed binocular vision. This is particularly the case in monocular aphakia not corrected with an intraocular lens; aphakia normally produces a high degree of hypermetropia.

b *Disadvantages of contact lenses*

The main disadvantages are the risk of intolerance and the handling difficulties. The contact lens is a foreign body placed upon the eye. Somewhat depending on the lens type used, short-term or long-term reactions may occur. Any lens may induce a slight corneal haze or swelling which alters the refractive properties of the eye but normally not the quality of the retinal image. The reduced oxygen tension, caused by the reduced cabin pressure, may result in corneal hypoxia – especially during long distance flying. A small grain between the lens and the cornea is extremely annoying and gives rise to photophobia and lacrimation. If the lens is not immediately taken out, corneal damage may ensue. Similar reactions are the result of bad contact lens cleaning and irregularities of the rear lens surface.

The most common long-term reaction is an inflammatory follicular swelling of the tarsal conjunctiva called giant papillary conjunctivitis (GPC). This reaction is less common with hard than with soft contact lenses. Symptoms are irritation, lacrimation, and a foreign body sensation. When outspoken, the reaction prohibits further use of a contact lens for a certain length of time (or forever). In some cases a soft lens must be replaced by a hard lens to prevent recurrence of the reaction. Another long-term reaction – especially due to improper

fitting – is ingrowth of blood vessels into the cornea which calls for immediate lens withdrawal.

In recent years, different types of bifocal contact lenses have been introduced. So far, experience with these lenses has been disappointing, mainly due to their pronounced tendency to defocus, thus providing a very unpredictable refractive effect. In the diffractive type of bifocal contact lenses, the optical quality of the lens is poor and they reduce the contrast sensitivity which makes them unsuitable for aviation purposes.

Bifocal contact lenses are not acceptable for correction of refractive errors in pilots.

c *Hard contact lenses*

Hard contact lenses are normally produced by solid methyl methacrylate. They are usually of small size and 'float' on the corneal surface. These classical lenses are not permeable to oxygen but because of their motion and size, their influence on corneal oxygenation is small. Other kinds of hard lenses are highly permeable to oxygen and are sometimes used as an alternative. Under hypobaric circumstances, a disadvantage of the high oxygen permeable hard lens is the reduction of the so-called contact angle of the material which will hinder the free mobility of the lens.

Hard contact lenses are usually recommendable for aircraft personnel if they are accepted by the wearer and if they do not alter corneal refraction significantly.

d *Soft contact lenses*

Soft contact lenses contain varying amounts of water and are more or less permeable to oxygen. They are usually larger than hard lenses and are tighter fitted. Soft contact lenses are as a rule more easily tolerated by the wearers. They are ordinarily, as are hard lenses, only worn during a restricted part of the day, up to about eight hours. A more recent type of soft contact lens is used day and night for periods of 2–3 weeks, the so-called continuous-wear or extended-wear contact lens. This type of lens calls for a particularly careful wearer selection and instruction and proper control measures.

The cockpit air is often extremely dry, less than 5% relative humidity is quite common. This may cause dehydration of the contact lens and ensuing steep fit and corneal oedema. The result will be changes of the dioptrical value of the contact lens, followed by reduced visual acuity. For this reason, soft contact lenses of low hydration may be advantageous for flying purposes.

e *Practical considerations*

Contact lenses should be carefully handled and cautiously cleansed at regular intervals. The user must be highly motivated and properly trained. Insertion, cleaning and sterilisation calls for a clean environment and special equipment. Contact lenses are difficult to replace if they are lost or displaced. This may be particularly complicated on the flight deck and clumsy insertion may cause corneal damage.

It has been reported that gas bubbles may form under contact lenses in rapid decompression. Within a pressurised cabin or at low altitudes, however, there should be no problems. Neither is it necessary to take into consideration the risk of contact lens loss due to high G-forces. Experiments have shown that contact lenses stay into place during flight manoeuvres normally encountered in civil aviation.

Before applicants are authorised to use contact lenses, a thorough examination should be performed by an ophthalmologist and a contact lens optician. Here, any kind of abnormality which contraindicates the use of contact lenses should be ruled out. It should be stated that the applicant is well adapted to the type of lens in question and that he can wear it without problems for the full duty period. Since contact lenses may give rise to long-term ocular

reactions, regular examinations should be called for. Unfortunately, the legislation governing the fitting of contact lenses and the medical supervision of the wearers varies greatly between countries. The licensing authorities must be observant of the proper fitting of contact lenses and regular medical control of the condition of the eyes. When contact lenses are first prescribed to a pilot, the medical monitoring should be very close, but after one year of observation, a control interval of 12 months will usually be adequate.

It should be pointed out to the applicant that a spare set of spectacles should also be at hand. Replacing a lost contact lens by the spare set of spectacles may not be fully compensatory if corneal curvature changes or corneal oedema has altered the refraction of the eye.

'Spectacle blur' is a term used about the reduced vision with glasses when used alternately with hard contact lenses. Spectacle blur is at its highest three days after removal of the contact lenses. For this reason it may be better to examine contact lens wearers directly after removal of the lenses. If the visual acuity or the measured refractive error is close to a border value, the lenses should not be worn for 2–3 weeks before definitive measurement of refraction is performed.

6 REFRACTIVE SURGERY

6.1 Radial keratotomy

During the latest decades, several different surgical procedures have been introduced in order to alter the refractive properties of the eye. The aim of these operations is to change the anterior curvature of the cornea. Most of them are complicated, demand a very high experience of the surgeon and are used on a limited number of patients. One of the methods, the so-called radial keratotomy, is easier to perform and has gained a considerable interest. In this operation, a limited number of radial incisions are made through the corneal stroma whereby the anterior surface is flattened. The method is used to reduce or eliminate myopia.

Large numbers of myopic subjects have been operated with this method. Experiences so far show that the myopia is reduced, and to a greater degree, in patients with larger amount of nearsightedness. It is not possible to predict the effect: some patients end up with hyperopia. Although complications due to the incisions are few, infections occur and have caused blindness. From the functional point of view, two problems are most relevant to aircraft personnel. One is that in some patients the refractive state is not stable and can vary more than 1 dioptre during the day. Another is an increased glare sensitivity due to the corneal scars.

This knowledge has led to the conclusion that subjects operated with radial keratotomy should not be considered fit for aviation duties since the function of the eyes is not normal. Subjects with myopia exceeding 3 or 5 dioptres should be warned against this way of fulfilling the visual requirements.

6.2 Photorefractive keratectomy

In photorefractive keratoplasty, laser radiation is used to alter the anterior curvature of the cornea by ablation of stromal substance. So far, subjects with myopia and astigmatism have been treated; the experience is greatest for lower degrees of myopia. The results are far more predictable and stable than with radial keratotomy and there seems to be few complications. A corneal haze during some months after surgery is, however, common. Increased glare sensitivity has been recorded postoperatively also in patients without visible haze and may be an objection to certification.

6.3 Certification

In cases where the pre-operative refractive error was less than 5 dioptres a return to flying duties may be possible after 12 months, provided that post-operative stability of refraction and visual function has been achieved and glare sensitivity is not increased.

7 APHAKIA

Aphakia means 'loss of lens', i.e. that the lens has been removed from the eye, in most cases because of cataract. Often cataract is simultaneous with, or caused by, other eye disease; a fact that should be considered in each case. The refractive power of the lens must be replaced in the aphakic eye and there are three current methods to do this.

7.1 Aphakia with spectacle correction

Aphakia gives rise to hyperopia of the order of 11 dioptres. There are significant optical disadvantages with glasses of this power: a large ring scotoma, peripheral distortions, a 'jack-in-the-box' phenomenon, and image enlargement. These preclude the use of aphakia spectacles in aviation personnel.

7.2 Aphakia with contact lens correction

Compared to the normal eye, the aphakic eye corrected with a contact lens has a somewhat narrower visual field. The optical properties of this correction are otherwise of minor significance. Because it takes time for the eye to heal after a cataract operation, a waiting period of six months following surgery is recommended.

7.3 Aphakia corrected with an intraocular lens

The optical properties of the aphakic eye with an intraocular lens are comparable to those of the presbyopic normal eye. In some cases, a large spherical or astigmatic error remains or is induced by the operation and should be duly paid attention to.

After an operation with the surgical experience and technique present today, the visual result is usually good and the condition stable after about three months. Immediate postoperative complications should, of course, not be present.

7.4 Recertification

In selected cases a return to flying duties may be possible after 3 months, provided that post-operative stability of refraction and visual function has been achieved and that the visual requirements are met either with contact lenses or with intra-ocular lenses in combination with spectacles. The use of spectacles as a sole means of correction (aphakia spectacles) is not acceptable (see paragraph 7.1 above)

Of practical importance are the progressive proliferations in the posterior lens capsule which give rise to increased glare sensitivity, impaired contrast sensitivity etc. This is quite common (up to 50%) after the procedure currently used, i.e. extracapsular cataract extraction and motivates regular controls by an ophthalmologist.

8 VISUAL FIELDS

With the eye held steady, light can be perceived within a solid angle (an asymmetric 'cone') pointing at the eye; this angle constitutes the visual field. Since it is awkward to illustrate this

three-dimensional space, the visual field is usually depicted as a two-dimensional projection of the space. Within the visual field, we see brightness and colour contrasts, identify object forms etc. As a rule, the visual functions deteriorate against the periphery of the visual field; spatial discrimination (i.e. visual acuity) and colour discrimination are both impaired when the object is moved from the fixation point. Colour of all hues (going from one end of the spectrum to the other one passes a series of spectral hues: red, orange, yellow, green, blue, violet etc.) can be seen to the outer limit of the visual field. Against the periphery, however, the object saturation has to be very high in order that the object be seen as coloured (saturation is a measure of 'colourfulness'; light of one wavelength has maximum saturation; white, grey and black no saturation). Colour naming is increasingly difficult the more peripheral the object is in the visual field.

It would probably be of large practical interest to measure the more complex visual functions within the visual field. One is, however, usually restricted to measuring the mere ability to detect objects with brightness contrast to the background. Objects with high contrast or large angular subtense are detected at a more peripheral angle. If, on a field chart, those points that have the same sensitivity are connected with lines, an isoptre is created. The isoptre corresponding to a very bright object gives the outer limit of the visual field. Objects with low contrast or small subtense give smaller isoptres (fig. 14).

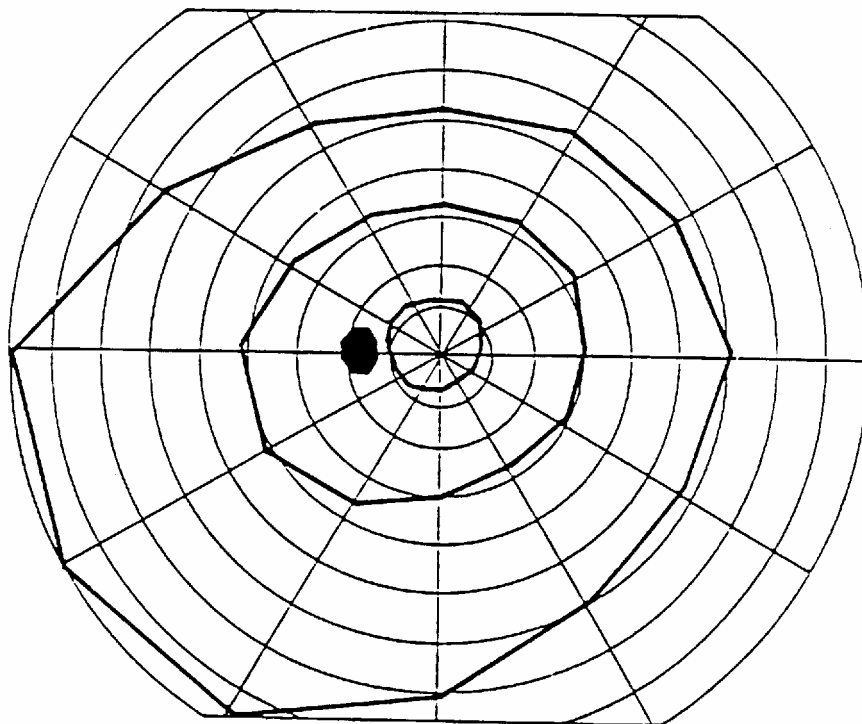

Figure 14 A normal left eye visual field with three isoptres. The outermost shows the outer limit of the field: the two smaller are produced with objects of lower brightness or size. The black area is the blind spot. The circles show the two-dimensional projection of every 10° of a hemispherical surface.

Abnormal, i.e. reduced contrast sensitivity gives rise to a visual field defect or scotoma. When the sensitivity is reduced but still present, we talk about a relative scotoma. When light is not perceived at all, the scotoma is called absolute.

8.1 Monocular and binocular fields

The monocular visual field extends further temporally than nasally and further downwards than upwards (fig. 14). The total extent of the horizontal meridian is about 150°. Nasally and upwards, the useful fields may be restricted by the nose and the brows respectively. The binocular visual field is the sum of the two fields when the eyes are fixating on a certain object (fig. 15). Within the central area, the fields overlap and on each side are temporal crescents solely belonging to one eye.

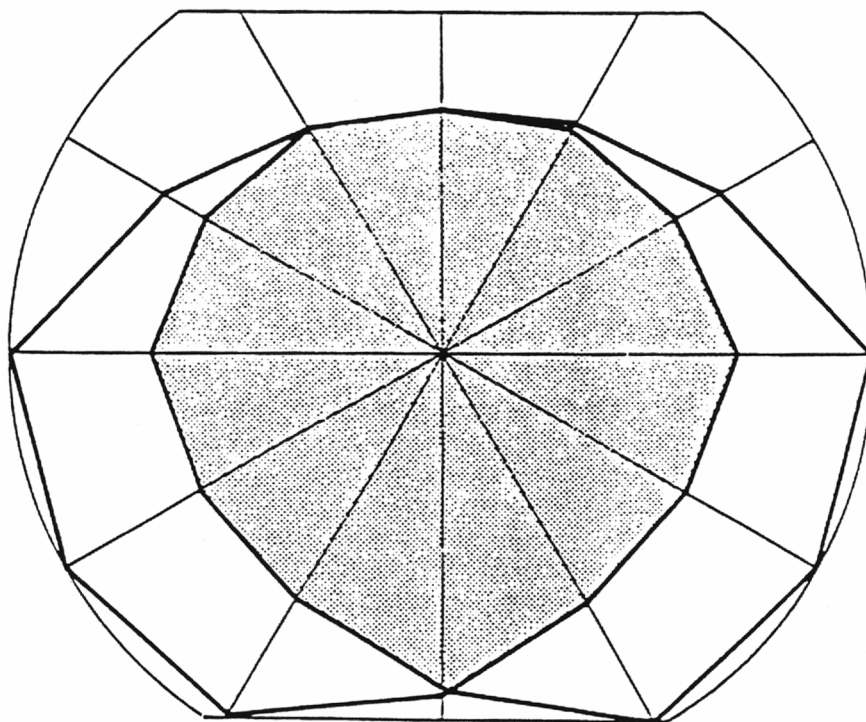

Figure 15 The binocular visual field. The central grey area is common to the two eyes whereas the temporal crescents are unique.

The field of gaze is a larger area determined by the size of the visual field(s) and the mobility of the eyes and the head. The field of gaze can, of course, be measured under monocular or binocular seeing.

8.2 Flight deck considerations

Inside the cockpit, the exterior field of vision is restricted by the size of the windscreen and cockpit windows. These are often narrow, and furthermore the ground is often partly hidden by the nose of the aircraft. Other crew members may conceal parts of the visual field as may broad or unwisely placed spectacle frames.

Hypoxia is said to cause a restriction of the outer limit of the visual field and an enlargement of the blind spot. The latter defect is found already at such low altitudes as 1 000–1 500 meters (3 000–4 000 feet). It has to be remembered, however, that this spot, even enlarged, is covered by the visual field of the other eye.

The extent and quality of the visual fields have a high theoretical validity for all kinds of aviation duties. With 'indirect vision' other aircraft, instrument dials, warning lights etc. are seen. How large the fields must be and what defects can be accepted without reducing safety is impossible to state. Thus, for safety reasons the requirements are very strict: both visual fields shall be normal. Deviations from this requirement are only possible under the waiver clause. Each visual field

defect must be individually judged. It is self-evident that small, monocular and peripheral defects are less important than large and central defects. Defects covering corresponding parts in the two eyes, i.e. homonymous defects, are particularly dangerous to flying.

8.3 **Methods of examination**

The visual field can be measured binocularly or, usually, monocularly. The most simple measurement, which can be performed without special equipment, is by so-called confrontation (the expression is derived from the fact that the subject and the examiner face each other). The most often practised method is that designed by Donders and named after him. Here, the applicant and the examiner face each other at a distance of about one metre. Both cover the corresponding eye (the right eye of one and the left of the other) and look into each other's seeing eye. The examiner moves his hand from the periphery towards the center and compares his own seeing with that of the applicant; the latter tells as soon as he sees the hand. This test, of course, demands normal visual fields of the examiner.

The visual field shall be tested in several meridians of each eye, preferably in the eight main meridians (12, 3, 6 and 9 o'clock and the oblique meridians in between). This way of testing the visual field is rough and insensitive and does not provide a basis for comparison or recording. Sensitivity can be increased by using a smaller object or by asking the applicant to tell whether the fingers are moving or steady. If, however, anything but large defects should be found, perimetry or campimetry should be used. These methods are also necessary for the precise recording of field defects.

a *Perimetry*

In the perimeter, an object of defined size and brightness is presented on a stable background. The background can be an arc moved in different meridians or, as most often today, a hemisphere. The object can be a stimulus patch moved by hand or a light dot projected on the background. If the perimeter has not its own illumination, it is essential that it is evenly illuminated by an external light source which must be kept unaltered between examinations.

The eye to be examined is first centred in the perimeter by adjusting the head-and-chin rest. The applicant is told to fixate steadily on the fixation mark or light and to signal when the stimulus is seen. In the bowl perimeters, central fixation can be checked via a telescope.

With a manual arc perimeter, a suitable target is moved by hand from the periphery until it is seen by the applicant. In this kinetic perimetry, several meridians are tested so that an isoptre for the object used can be mapped. With a large object of high contrast, the outer limits of the visual field are found. Using smaller objects of lower contrast, smaller isoptres are recorded as is necessary in order to find subtle defects of retrochiasmal origin.

Projection arc perimeters show a round or oval object which, likewise, is moved from the periphery towards the centre in various meridians. As with the objects moved by hand, at least eight meridians should be tested. If a scotoma is found, it can be mapped by moving the object from the centre of the defect in various directions.

The arc perimeters have largely been replaced by the bowl perimeters. Here the subject is placed with his eye to be tested in the centre of a hemisphere which is evenly illuminated (usually to 10 cd/m²). A light dot of variable brightness and size can be presented anywhere within the hemisphere via a projection system. Most often performed is kinetic perimetry where a varying number of isoptres is recorded by steady movement of different objects in several meridians. Examination is fairly simple to perform and evaluate. Precision is high and even small defects are detectable by this kind of perimetry. Unfortunately, the apparatuses are rather expensive.

b *Automated perimetry*

Manual perimetry is tedious and subject to variations between examinations due to the examiner's experience, expectation bias etc. To overcome these disadvantages, a number of automated perimeters have been constructed. Almost all of them work by static perimetry, i.e. fixed stimuli varying in stimulus brightness. The stimuli are located in areas of particular interest for detecting various field defects. There are programmes for screening and for finding scotomas caused by glaucoma or neurological diseases. A computer directs the random selection of stimulus location and target brightness. In some screening programmes, all stimuli are of the same intensity above threshold. In other programmes, which are more sensitive, intensity is adjusted to the overall threshold increment against the periphery. Some perimeters measure the threshold sensitivity in some or all points chosen.

Automated perimetry has been shown to be highly sensitive in finding visual field defects. Reproducibility is high because the variations caused by the examiner have been eliminated.

High pass resolution perimetry is a new method where the subject only detects the object (a ring) if it is discriminated by other visual channels than those active in luminance contrast detection. This method has proved to be more sensitive to the loss of visual channels than ordinary perimetry and is easily performed. The outcome clearly shows – also to the subject – an impairment of the visual field.

c *Campimetry – tangent screen*

In campimetry, the applicant faces a black screen of 1.0, 1.5 or 2 metre square at a distance of 1 or 2 metres. Targets attached to a black rod (or projected light spots) are used to map small isoptres or central and paracentral scotomas. Test equipment is cheap and the method highly sensitive. It demands, however, great experience and is not suitable for visual field screening. It is mainly used to find and follow glaucomatous visual field defects and to reveal malingering.

8.4 **Visual field defects**

Visual field defects are caused by diseases within the eye, the optic nerve, the optic tracts and optic radiation, and the occipital lobe. Lesions located in front of the chiasm cause a defect of one eye. Chiasmal disturbances give complex defects, usually in both eyes. When located behind the chiasm – a retrochiasmal disorder – the lesion gives rise to defects of the contralateral half of the two eyes. In general, these defects are more congruent the further posteriorly the lesion is.

Media opacities (as cataract) may reduce the retinal illumination and the image quality giving a generally reduced sensitivity within the visual field.

Retino-choroidal disorders cause reduced sensitivity in the area affected. Examples are retino-choroiditis and retinal detachment. If the function of a nerve-fibre bundle is likewise affected, wedge-shaped defects may ensue. In retinitis pigmentosa, an annular scotoma is characteristic in the early phase.

In glaucoma, the most frequent early defect is a paracentral scotoma within the central 15–25°. With progressive disease, the number of scotomas and their size increase, and they may coalesce to the characteristic arcuate Bjerrum scotomata which stretches from the blind spot to the nasal hemi-field. A so-called nasal step is also an early finding (fig. 16). Late in the course of the disease, the last remaining areas are usually the central field and a temporal island.

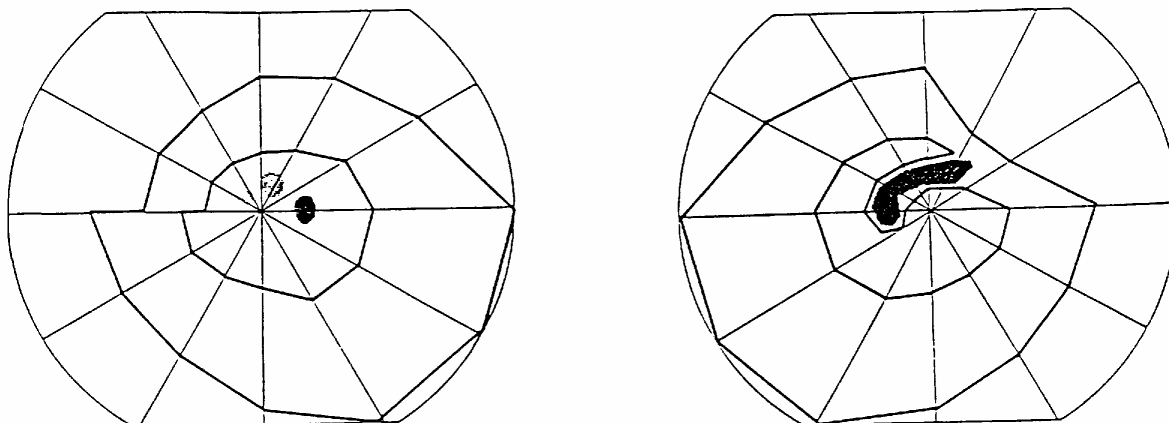

Figure 16 To the left early glaucomatous visual field defects; nasal steps in the upper field and two paracentral relative scotomas. To the right a Bjerrum scotoma with an absolute scotoma inside (dark area).

Optic nerve disease most often gives central/paracentral defects (fig. 17). The central lesion also typically affects visual acuity and colour vision.

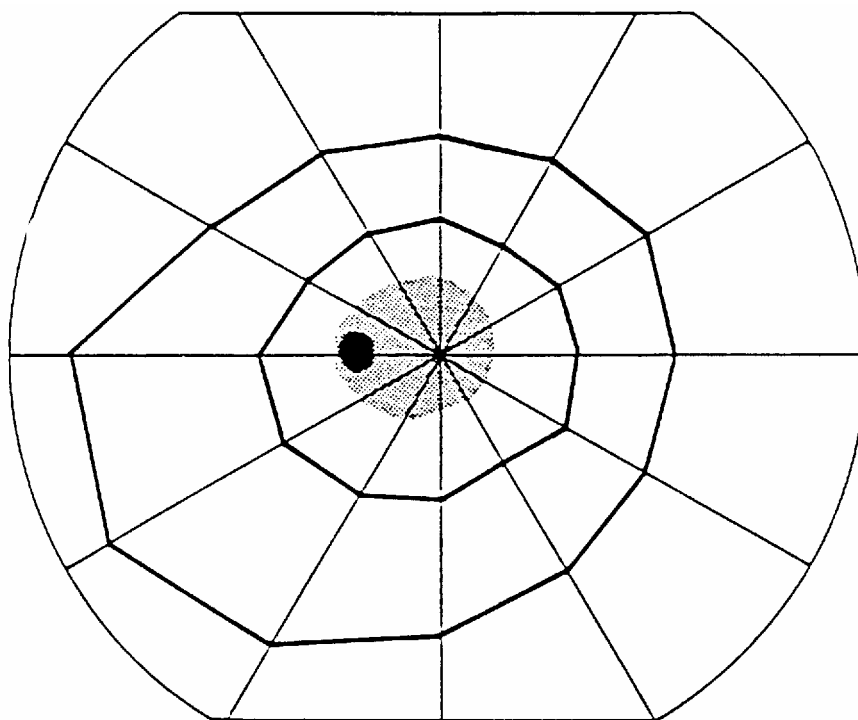

Figure 17 A caecocentral scotoma , i.e. a depression in the visual field including the fixation point and the blind spot.

A lesion in the middle of the chiasm primarily affects the two temporal hemi-fields (fig. 18), as in tumours of the pituitary gland (hypophysis).

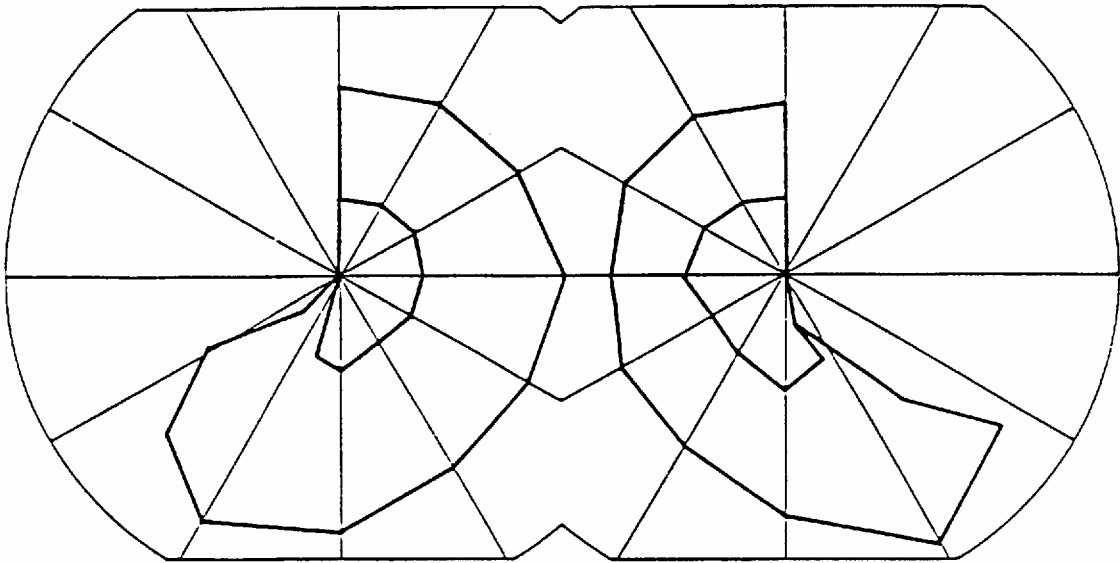

Figure 18 Bitemporal field defects, in this case caused by a tumour compressing the chiasm from below. This way the field defects are more outspoken in the upper parts of the fields. Small isoptres are typically more affected than the larger.

Retro-chiasmal defects are more or less congruent and only affect one half of the visual fields. Depending on the size and location of the lesion, small or large parts of the fields are disturbed (fig. 19).

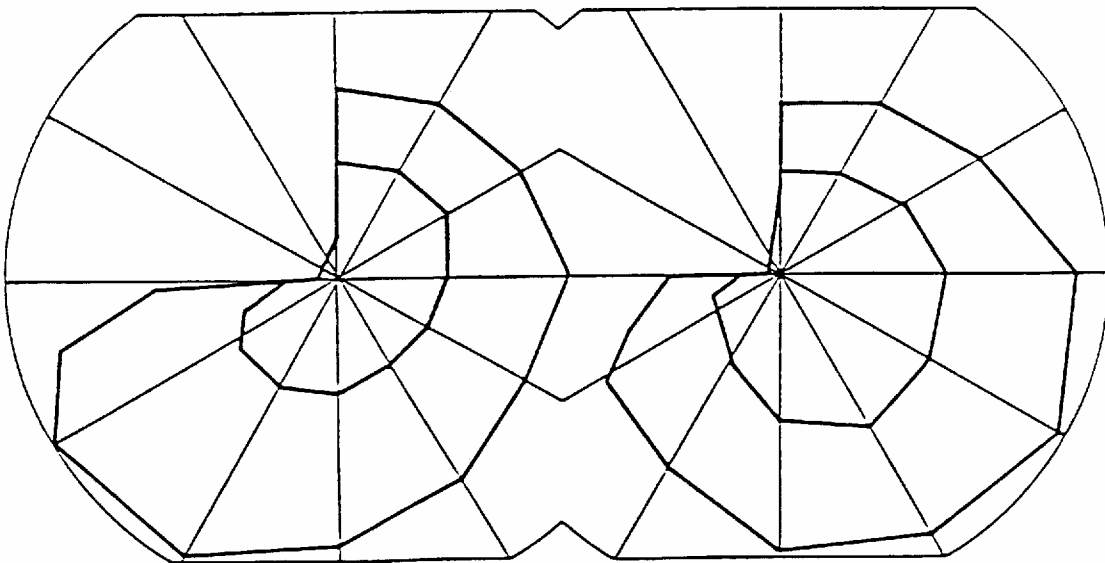

Figure 19 Homonymous upper left quadrant defects.

9 OCULAR MUSCLE BALANCE – BINOCULAR VISION

9.1 Stereopsis

The two eyes are normally directed at the same point. Stereopsis is made possible by virtue of the binocular seeing of the same visual scene, as there is a small difference between the images of

the two eyes. This capacity to determine the third dimension of the visual space is most important for near objects. Beyond about 30 metres distance, its importance is negligible. In theory, aviation personnel should benefit from stereopsis when judging short and intermediate distances. The practical importance has, however, never been proven.

There are also a number of monocular clues for judging depth. Among these are the fact that nearer objects cover more distant ones, the known dimension of certain objects, parallax movements and an apparent colour desaturation at great distances. These monocular clues are most important at greater distances and do not depend on cooperation between the two eyes.

9.2 Heterophoria

The direction of gaze of the two eyes against the same point is made possible by fusion of the images. When fusion is artificially broken, e.g. by covering one eye, the non-seeing eye takes up its resting position. In a few cases, the covered eye remains aligned with the other eye; the subject is said to be orthophoric. In most cases, the covered eye deviates before taking up the resting position. If fusion is readily accomplished when the eye is uncovered, the subject is said to have a heterophoria. Heterophoria, or latent squint, thus means that the two eyes cooperate normally most of the time because the fusional strength is greater than the tendency to squint. Most heterophorias are small, and the fusional effort necessary to compensate for it, is modest.

There are several forms of latent squint:

- a esophoria – tendency to deviation inwards
- b exophoria – tendency to deviation outwards
- c hyperphoria or hypophoria – tendency to vertical deviation
- d cyclophoria – tendency to rotational deviation.

Heterophoria can give rise to eye-strain due to the constant fusional effort necessary. Although large heterophorias are more prone to give symptoms, there is no direct correlation between the magnitude of latent squint and the subjective troubles. If an applicant complains of asthenopia or headache and is corrected for a possible refractive error but has a heterophoria, the latter may be the cause. It is then worth trying to correct the heterophoria with orthoptic treatment and later, possibly, with an operation of the ocular muscles. The addition of (small-angle) prisms to spectacles is controversial in aviation.

If the fusional strength is weak or further weakened by fatigue or the influence of drugs, the balance between fusion and tendency to squint may be upset. One eye then deviates: the heterophoria is said to be decompensated giving an intermittent squint. If diplopia follows the misalignment, it is a potentially dangerous situation. Again the evaluation of the condition is complicated for several reasons. First, suppression (see below) may prevent double vision in spite of the ocular deviation. Secondly, it is very difficult to establish whether a heterophoria at times will be decompensated. The magnitude of the heterophoria in itself is not conclusive because the fusional strength varies between individuals (maximum values for heterophorias as stated in visual requirements JAR–FCL 3.220(f) – *vide infra* – are only for guidance as to when fusional reserves should be assessed). The fusional range or an estimate of the fusional strength are supportive measures but they are difficult for a non-expert to determine. In cases of large heterophorias or suspected decompensation with double vision, as in cases with suspected ‘jump of localisation’, the applicant should be referred to an ophthalmologist acceptable to the AMS.

9.3 Strabismus

Strabismus or squint infers that the two visual axes constantly point in different directions. The condition may arise at any age, but most cases develop in childhood. The reason may be defective fusional strength, abnormal vision of one eye (or both), or an oculomotor disorder. Different forms of strabismus are named corresponding to the heterophorias: esotropia, exotropia, hypertropia, hypotropia, cyclotropia.

If strabismus develops in childhood, double vision is prevented by suppression of one eye or both eyes. Those areas of the visual field that are most disturbing are quite simply 'uncoupled' and the sensitivity of other areas altered. In esotropia, e.g. the fovea and the area corresponding to the fovea of the other eye are deeply suppressed. This way, the visual acuity of the squinting eye is permanently reduced unless treatment is given. When the squinting eye is forced to see, e.g. by covering the other eye, suppression is more or less completely released. The squinting eye may be 'locked' in the abnormal position by developing an altered directional sensitivity, an anomalous correspondence. If such a case is operated so that the eyes are aligned, double vision may ensue.

In the case of strabismus present since childhood, the patient is usually trouble-free. One eye is as a rule preferred and the other is suppressed so that double vision is eliminated. Vision in the larger part of the squinting eye's visual field is almost normal; it follows that the binocular visual field is affected only to a minor degree unless there is a large angle of esotropia (when one eye is looking towards the nose, vision to the side is restricted). Some patients alternate eyes; the eye 'turned on' works normally (with normal visual acuity) and the other is suppressed, particularly in the central visual field. By alternation, the first eye is 'turned off' and the suppression in the other eye released etc.

In a strabismus that develops after childhood, diplopia can not be eliminated by suppression. Most of these cases are decompensated exophorias which turn into an exotropia. These patients acquire double vision which is extremely annoying. Since some fusional strength usually remains, treatment by alignment (orthoptic, optical or operative) may be successful and should be started early.

A paralytic strabismus is due to a paralysis of one or several ocular muscles. If it occurs in childhood, suppression sets in. Most patients are, however, adult, and they generally first notice their disease by double vision. The misalignment and the degree of diplopia increases when the eye is moved in the direction of the paralytic muscle.

9.4 **Convergence**

Vergences, or disjunctive eye movements, provide us with the ability to fixate points at various distances in visual space. In convergence the visual axes of both eyes are rotated inward whereas in divergence the movement of the eyes is outward. Vergence movements play an important role in the maintenance of binocular vision and oculo-motoric fusion. Insufficiency of convergence is one of the most common causes of ocular discomfort and asthenopia.

Under normal conditions the act of convergence is associated with accommodation and miosis (forming together the triad of the near reflex). The balance between convergence and accommodation is affected by optical correction of refractive errors, a fact that has to be considered when spectacles are prescribed.

Convergence is assessed in relation to the other eye movements, to the presence of heterophoria, and to the oculo-motor system.

9.5 **Examination techniques**

Examination starts with a thorough case history. Eyestrain, ocular or frontal headache and double vision should especially be asked for. In the case of strabismus, it is of value to clarify its debut and the treatment given.

Abnormal head position should be looked for. In some types of strabismus, diplopia is compensated by head rotation or tilting.

At the examination, the oculomotor function and the binocular cooperation are studied.

A strabismus of some magnitude is overt. Small-angle strabismus and heterophoria are best revealed by the cover-test. In the simple cover-test, one eye is occluded with the aid of a hand, a spoon or the like. The non-covered eye is watched. If it takes up fixation after a corrective movement, it was misaligned and a strabismus is proven. The simple cover-test is done first by occluding one eye, then after a short pause the other (fig. 20).

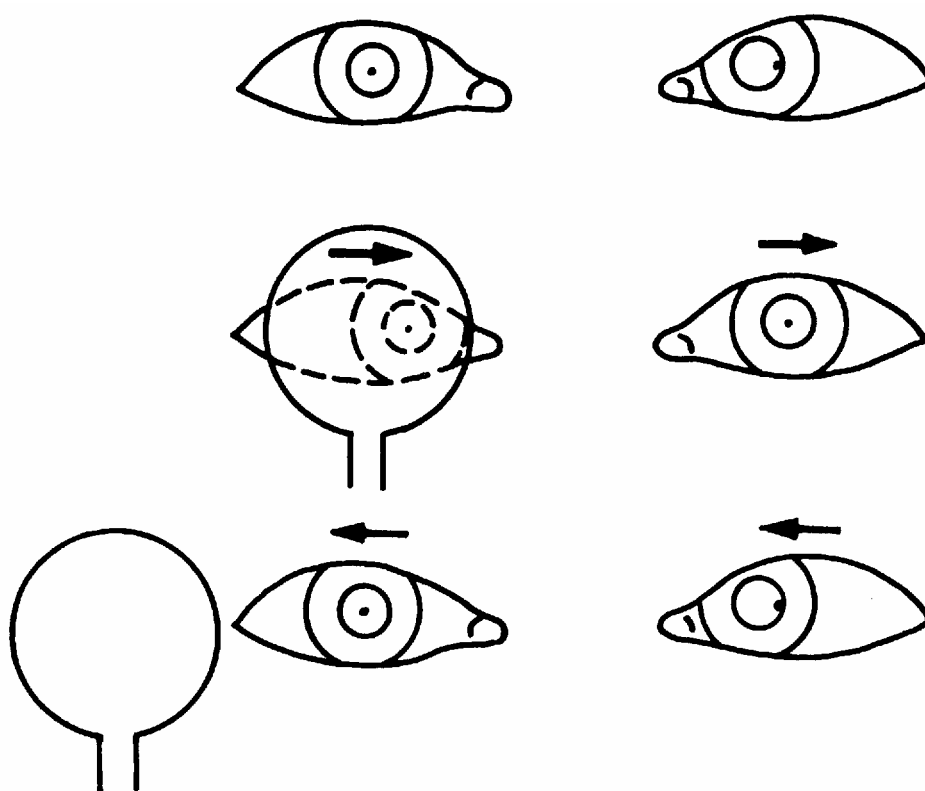

Figure 20 In the simple cover test, one eye is occluded and the other eye is watched. If it moves, it was not aligned before covering. (A case of esotropia of the left eye is shown.)

To disclose a heterophoria, the alternating cover-test is used. One eye is covered and after a few seconds the occluder is quickly moved to the other side, then after a while back again (fig. 21). This way, fusion is blocked and the eyes take up their resting positions. The uncovered eye is watched. If it moves, the eyes are not parallel and a heterophoria is proven. Strabismus gives rise to corrective movements with the simple and the alternating cover-tests, heterophoria only with the latter.

Further information is gained by watching the eye movements. The applicant is asked to fixate an object which is moved in different directions. These are, from the primary position, upwards and downwards, to the right and to the left, and upwards and downwards at gaze to the right and the left. A gaze paralysis reveals itself by restricted movements of both eyes in certain directions. A

peripheral oculomotor paralysis is shown by limited movements of one eye. The patient is asked for double vision in any direction of gaze. To disclose a misalignment, the cover-test can be used in all gaze directions. To establish which muscle is affected, a coloured filter can be used in front of one eye in combination with a small luminous object.

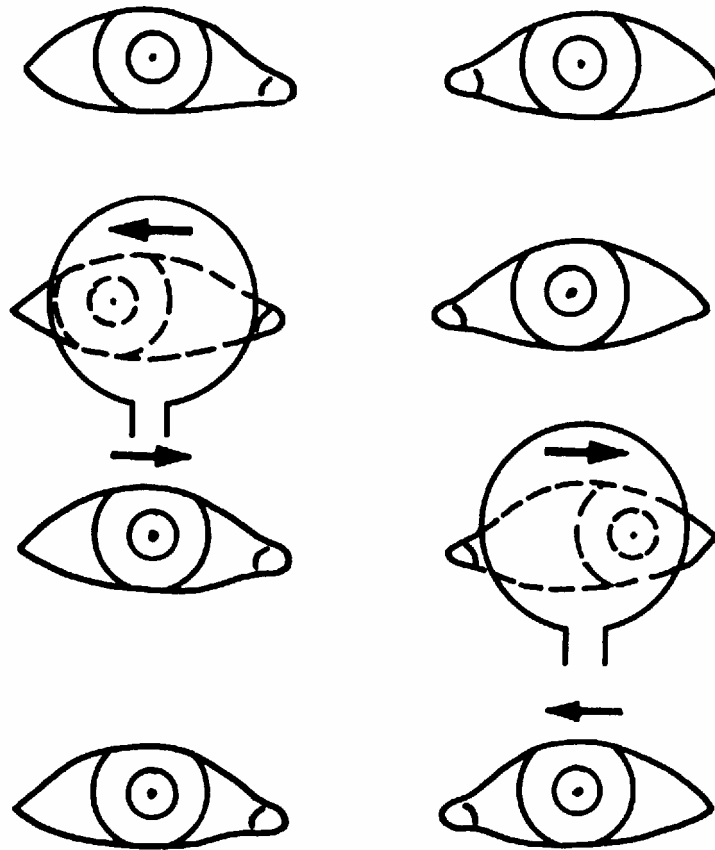

Figure 21 In the alternating cover test, the occluder is moved between the two eyes. This way fusion is blocked and a heterophoria revealed. The non-covered eye is watched. (A case of simple exophoria is shown.)

To measure the magnitude of heterophoria or strabismus several methods exist. The best one is to combine the cover-test with prisms placed before one eye. In esophoria and esotropia base-out prisms are used. Their power is increased until the corrective movement is eliminated. In exophoria and exotropia the base is placed nasally. This method does not depend on the applicant's cooperation in any other way than steady fixation. It can be performed with fixation at near or at a distance.

The degree of strabismus can also be roughly estimated by looking at the corneal reflexes of a point light source.

Heterophoria can also be measured with a so-called Maddox rod. Through this rod, a bright light source is seen as a line and fusion is therefore broken. Measurement is made with the aid of a ruler attached to the wall or, simpler, with a graduated device with a built-in Maddox rod and a rotary prism. Heterophoria at near is easily measured with the Maddox wing test (the detailed use of these tests is best learnt with the instrument at hand).

The fusional range is measured with prisms placed in front of one eye. Prism power is successively increased until fusion is no longer possible and double vision ensues. Testing is done with fixation at near or at a distance.

Squint angles can also be measured with an apparatus called the synoptophore. With this complicated instrument, a somewhat artificial situation is created and testing is considered less valid than that done in free space.

To reveal possible suppression of one eye the Worth four-dot test can be used. Four objects, white, red and green, are watched with a red filter before one eye and a green before the other. The subject only perceives the dots visible to the non-suppressed eye(s) – their colour determines which eye it is. If all four dots are seen, the eyes cooperate. If more than four dots are seen, a squint without suppression is proven.

Convergence is measured and expressed as the near point of convergence (not to be confused with the near point of accommodation).

The near point of convergence is determined by placing a fixation object – as for example the black line on the RAF Near-Point-Rule – in front of the eyes of the examinee. The visual object is then slowly moved towards the eyes until one eye loses fixation and turns outward. The distance (in centimetres) at which this occurs is the near point of convergence. Normal values are usually between 6 and 8 cms. If the near point is 10 cms or more the convergence is insufficient.

9.6 **Stereoscopic Vision**

No specific stereoscopic requirements have been established, albeit stereoscopic visual ability does express the standard of the binocular function. Thus testing of the stereoscopic visual acuity may be used as a valid screening measure of the central binocular function. The usual tests (e.g. Titmus and TNO or similar) measure the smallest disparity, expressed in seconds of arc, that can be recognised (disparity: difference between the images from the two eyes). A test result better than 60" is usually regarded as normal.

10 **COLOUR VISION**

Colour contrast aids in detection and identification of objects in the visual scene. Colour is a quality of the mind given to light of a certain spectral composition in a certain state of ocular adaptation. Psychologically, colour can be described by the three qualities hue, saturation and lightness. These have psychophysical counterparts which can be given colorimetric figures in order to characterise the colour in question.

The early use of colour in sea and land traffic was limited by the techniques available to produce light of sufficient saturation and brightness. Therefore only red, yellow (white) and green signals were adopted and their significance is today so deeply rooted in us all that they cannot be exchanged. This is unfortunate, since all people do not perceive colour in the same way and exactly these hues give rise to separation difficulties. Although attempts have been made to minimise the use of colour contrast as the sole characteristic of a stimulus, colours are still used to such an extent that some applicants have to be rejected for safety reasons.

10.1 **Colour vision physiology**

The person with a normal colour sense is called a normal trichromat. This person perceives as light electromagnetic radiation of wavelengths between about 400 nm (violet) and 700 nm (deep red). Maximum spectral sensitivity is at 555 nm (yellow-green). A normal trichromat can discriminate between more than 100 hues in the spectrum; the wavelength discrimination varies

somewhat in the spectrum. By adding saturation and lightness differences, several hundred thousand different colours can be discriminated. Stimulus variables which affect colour perception are the angular subtense, duration and brightness.

Normal colour vision is made possible by the presence of three different kinds of cones with each one light absorbing pigment.

10.2 Colour vision deficiencies

The congenital, hereditary colour vision deficiencies are of different quality and severity. More than 99.9% of them affect the perception of red, red-purple, green and blue-green.

Monochromacy or achromatopsia means total absence of colour perception. These rare disorders exist in several forms; the most common is combined with low visual acuity, nystagmus and photophobia.

For a person with dichromacy, some hues are completely desaturated and impossible to distinguish from each other and from neutral grey. Wavelength discrimination is severely disturbed.

Anomalous trichromacy is a less pronounced defect. Subjects with such an anomaly show, compared to normal, increased thresholds for saturation and wavelength discrimination in certain spectral regions.

Congenital dichromacies and anomalous trichromacies exist in the following forms:

	Dichromacy	Anomalous trichromacy
Red-Green defects	Protanopia Deuteranopia	Protanomaly Deuteranomaly
Yellow-blue defects	Tritanopia	Tritanomaly (?)

The red-green defects are inherited as Xlinked recessive disorders and are fairly common: 8–10% in caucasian men, in women about 0.5%. In men, deuteranomaly is most frequent: about 5%; the other three red-green defects affect approximately 1%. The yellow-blue defects are rare, about 1 in 50 000.

Protanopia and deuteranopia have been shown to be caused by the absence of one of the retinal cone pigments; the presence of not more than two pigments only makes possible the perception of two hues. The lack of the long wavelength sensitive pigment in protanopes results in lost sensitivity to deep red light which is perceived as black. In protanomaly and deuteranomaly, an abnormal pigment has replaced a normal one. Also the protanomalous subjects have reduced sensitivity to long wavelength light. The reason for the tritan defects is supposed to be alterations in the short wavelength sensitive pigment.

Protanopes confuse red and blue-green, deuteranopes green and red-purple. In protanomaly and deuteranomaly, separation difficulties arise with the same hues, although only those of low saturation, low brightness or small angular subtense. The anomalous trichromacies vary in severity and some are almost as pronounced as the dichromacies: extreme anomalous trichromacy.

Borderline cases between normal trichromacy and anomalous trichromacy are pigment amblyopia and colour asthenopia. The former confuse pigment colours, e.g. those on pseudo-isochromatic charts but pass other colour vision tests. Colour asthenopia is essentially an increased 'fatigue' to spectral lights. These and other borderline cases are usually considered as normals in practice.

The rare congenital tritan deficiencies cause confusion between violet and yellow colours.

Congenital defects are unaltered with age and cannot, contrary to what is sometimes claimed, be treated in any way. Tinted filters, e.g. the so-called X-chrom lens, make possible a better

discrimination of some confusion colours but do not improve colour perception. Applicants passing a colour test by the use of such a device are not 'colour safe'.

Acquired colour vision deficiencies arise from diseases in the eye or the visual pathways. An ocular disorder most often gives rise to a yellow-blue defect. It is generally combined with other visual disturbances like reduced visual acuity or visual field defects and the ocular damage is thus overt. Of greater practical interest is the red-green deficiency caused by an optic nerve lesion. Such a problem invariably accompanies an optic neuritis and may result in difficulties in identifying colour signals although the visual acuity is normal.

With increasing age and density of the yellow lens pigment, a slight degree of tritanomaly follows.

10.3 **Practical considerations**

In aviation, colour is used in signals, instruments, signs, and print. The coloured object can be self-luminous (lamp + filter, LED or colour phosphor) or can be produced with pigment colours. In the latter case, the colour appearance depends on the character of the illumination. In some cases, a luminous contrast to the background is also present, and the identification of the colour is of assistance but not necessary to read the information. In other cases, e.g. navigation lights, the hue is the only clue to the correct identification. With the technical evolution, some colour signals have lost much of their significance because the message they convey has been taken over by other instruments. At the same time, a number of new colour applications have been introduced. The most recent is the colour display which presents data in a number of different hues and saturation steps. Luminous contrast is not always present and it seems most possible that the displays can give rise to practical difficulties for colour defectives. The evolution is very rapid, and the colour characteristics of the displays largely unknown. These instruments have created a serious problem which, until more knowledge is attained, necessitates a much less liberal attitude to colour vision abnormality.

As regards to the use of colour in civil aviation, some information is used only at night and other only in more advanced aviation. It is not self-evident that normal trichromacy is a necessity in all situations. By setting standards for the chromaticity of various colours, an attempt has been made to make their identification easier for air personnel with a colour deficiency.

The mere qualitative diagnosis of the colour vision deficiency is not sufficient, because the colour discrimination varies considerably between individuals with the same type of defect.

A practical colour vision test certainly has the highest validity but only for the conditions present at the test. It has been the practice of some countries to waive applicants with simple deuteranomaly who readily pass lantern tests. In some cases, a practical test with a signal gun has been decisive. Even individuals with rather outspoken defects may pass this test which does not signify whether the applicant normally perceives other less conspicuous signals.

In order to assess the fitness of an applicant with a colour vision deficiency with regard to a possible waiver, it is necessary to have at hand the results of a battery of colour vision tests. As many different aspects of colour vision as possible should be examined.

10.4 **Tests of colour vision**

Colour vision tests are produced to identify individuals with colour vision deficiencies, to classify them, and to screen those with a mild defect from those with a more severe defect.

The most readily available tests for screening are the pseudo-isochromatic plates. Most of them are made only for detection of red-green deficiencies; some series have plates which enable a classification and graduation of severity. The different series perform the screening task more or

less well; among well-known series are those of Ishihara, Dvorine, Stilling-Velhagen, and Boström-Kugelberg. These tests effectively separate normal from colour defectives. There are, however, subjects who fail only a few plates and in these cases a definite diagnosis is only possible with the aid of an anomaloscope.

There is a weak correlation between the number of failed charts and the severity of the defect; dichromats usually fail more plates than do anomalous trichromats. The classification of protans and deutans is not always possible with the charts. The American Optical Hardy-Rand-Rittler plates are especially designed for qualitative and quantitative diagnosis. These tasks are better fulfilled with this series than with any other plates. Unfortunately, this test, which is also excellent for testing acquired defects, is no longer available.

Testing with pseudo-isochromatic plates should be performed according to the instructions given by each test. It is important that the quality of the illumination is correct: either northern daylight or an artificial daylight source should be used. Ordinary incandescent lamps or fluorescent tubes make these tests easier to pass, especially to deuteranomals. The daylight source should give an illumination equivalent to the standard illuminants 'C' or 'D' of CIE (Commission Internationale de l'Éclairage). The plates should be shown at right angles to the visual axis of the applicant, at the correct distance and for the time specified in the test. The applicant should not wear tinted glasses. The number of failed plates serves to classify the subject as normal, defective or 'doubtful' according to the specifications of the test.

In the assortment tests, the subject is asked to arrange a number of coloured chips or to separate them into coloured or neutrally tinted. Of these tests, the Farnsworth Panel D-15 effectively parts subjects with minor defects from those with more severe defects. The test is easily performed and evaluated and, when failed, gives a qualitative diagnosis. It may be used as a valuable adjunct to other tests.

The exact qualitative and quantitative diagnosis is given by the anomaloscope. Looking into this instrument, the subject compares two juxtaposed fields and judges when they appear identical. Red-green deficiencies are studied with the 'Rayleigh match' where one field is yellow and the other an additive mixture of red and green. The examination demands a thorough knowledge of colour vision physiology and large experience. Most widely known and used is the Nagel anomaloscope, but equally efficient other apparatuses have recently been put on the market (e.g. Heidelberg Anomaloscope from Oculus). All dichromates should be rejected as they are colour unsafe. When examining an anomalous trichromate with Nagel's anomaloscope, different scale readings are used to express the result. The colour matching range is defined as the difference between the maximum and the minimum scale reading accepted by the examinee as identical to the test colour. If the colour matching range exceeds four scale units, the applicants must be considered *colour unsafe*. The relation between the mean scale reading for colour identity and the standard scale reading is expressed by the anomaly quotient. This quotient has diagnostic value, but provides no guidance in assessing colour safety. The anomaly quotient per se is thus irrelevant in the assessment of an applicant's fitness for flying.

The lantern tests are produced to test the ability to identify the hue of signal colours; they are meant to simulate the practical situation. There are a number of different lantern tests. In some of them, fixed red, white and green stimuli are presented. In others, there are extensive possibilities to vary the hue and saturation of the stimuli as well as the aperture size and presentation time. The possible advantage of being able to vary the stimuli is counteracted by the lack of knowledge of what these differences signify. Well known lantern tests are those of Edridge-Green, Giles-Archer, Beyne, Farnsworth, and Holmes-Wright. At present, however, only the lanterns of Holmes-Wright and of Beyne have been approved for assessing colour deficient pilots as to whether they can be considered colour safe or not.

The correlation between lanterns and practical colour recognition is weak and has never been properly examined. It is not established how the performance on these lantern tests is related to the 'ready perception of colours necessary for safe duty performance'. Without this knowledge, it is safest to follow the norms given for each test.

The Holmes-Wright lantern has an aperture size of 1.6 mm, corresponding to a visual angle of 0.9 minutes of arc. The light intensity is 2 000 μ -candelas for demonstration, 200 μ -candelas for daylight testing and 20 μ -candelas for testing in complete darkness. The lantern is easy to use. The examinee is placed in front of the lantern at a distance of 6 metres. Five different colours are presented: two red, two green, and one white light stimulus in nine different combinations, each presenting two colours (which may be identical in some of the presentations). The 2 x 9 fixed stimuli are presented for two to three seconds each and the examinee must identify the colour of each without delay. If all colours are correctly identified, the lantern test has been passed. If the examinee makes two or more errors, the lantern test has not been passed and the examinee is classified as colour unsafe. If the examinee makes one mistake or shows uncertainty during the test run, the lantern test is re-performed by executing two consecutive runs of the nine presentations. No errors or mistakes are allowed during this second run.

The Beyne's lantern (lanterne chromoptométrique de Beyne) presents the colours green, red, blue, white, and yellow-orange with an aperture size corresponding to a visual angle of 3 minutes of arc. Each colour is shown for one second. The examinee is placed in front of the lantern at a distance of 5 metres. No errors are accepted.

In summary, a vast amount of work still has to be done in order to establish which colour vision deficiencies can be accepted without loss of safety. Firstly, the colorimetric properties of all colours in use have to be determined, a task recently made even more difficult by the introduction of the colour displays. Secondly, one has to analyse how the identification and discrimination of these colours is influenced by the different types of deficiencies and, finally, it must be decided if an existing or future colour vision test can effectively divide applicants into 'colour safe' and 'colour unsafe' groups.

11 PATHOLOGICAL EYE CONDITIONS

In this chapter eye conditions are listed which can or will influence visual performance. Some of them are so grave and their symptoms so pronounced that applicants possessing them will be assessed as medically unfit for licensing without further ado. In other cases, the applicant may be assessed as medically fit after a thorough ophthalmic examination and based on an accredited medical conclusion.

Some of the conditions listed below are of a progressive nature. Applicants with such a disorder which fulfil the visual requirements should be advised that acceptance may be limited and regular examinations be instituted depending on the nature of the condition.

The following conditions are usually associated with reduced visual performance and may therefore entail medical unfitness for licensing purposes.

11.1 Eyelids

Disorders of relevance influence the position or motility of the lids or cause ocular irritation.

- a Ptosis interfering with the extent of the visual field
- b Lagophthalmos (inability to close the eyelids) which causes corneal desiccation
- c Scars and adhesions which affect normal eye movements

- d Tumours and lesions which interfere with the protective functions of the lids
- e Abnormalities of the lid margins causing trichiasis or chronic irritation of the lids.

11.2 Lacrimal system

- a Any disorder which gives rise to the dry eye syndrome with ensuing ocular irritation and visual impairment
- b Obstructions of the lacrimal outflow system with significant epiphora or recurrent inflammations.

11.3 Conjunctiva

- a Diseases which limit lid or ocular mobility and thereby cause deficient eyelid closure or double vision
- b Affections of the conjunctival glands interfering with proper tear film production (dry eye).

11.4 Cornea

- a History of recurrent keratitis or corneal ulcers
- b Corneal scars which influence visual function
- c Keratoconus or corneal dystrophy. These diseases usually lead to reduced visual acuity in the long run.

11.5 Uveal tract

- a History of recurrent anterior uveitis (iridocyclitis)
- b Sequelae after anterior uveitis causing increased glare sensitivity or similar problems; secondary glaucoma
- c Posterior uveitis giving rise to reduced visual acuity or visual field defects
- d Congenital malformations with visual impairment.

11.6 Retina

- a Hereditary degenerations with progressive influence on visual acuity and visual fields (e.g. retinitis pigmentosa)
- b Any macular degeneration which interferes with visual function
- c Retinal detachment
- d Vascular disorders with exsudates, bleedings or ischemic retinal damage.

11.7 Optic nerve

- a Optic neuritis
- b Optic atrophy
- c Both these disorders cause visual impairment by reduced visual acuity, defective red-green colour sense and central-paracentral visual field defects
- d Optic nerve head *drusen* or senile plaques.

11.8 Lens

- a Lens opacities (cataract) affecting visual acuity or glare tolerance
- b Aphakia not corrected with an intraocular lens: hyperopia of high degree
- c Dislocation of a lens, partial or complete.

11.9 **Miscellaneous defects and diseases**

- a Glaucoma (dealt with in detail below)
- b Tumour of the eye or the orbit
- c Inflammatory orbital condition
- d Disorders affecting ocular motility, e.g. orbital trauma, extraocular muscle paralysis, endocrine myopathy
- e Nystagmus with reduced visual acuity
- f Impaired pupillary light reflexes (drugs, trauma, inflammations)
- g Night blindness (nyctalopia, hemeralopia).

11.10 **Practical Considerations**

a *Optic Neuritis*

30–60% of patients with optic neuritis will later develop multiple sclerosis. The risk of developing multiple sclerosis is reduced in patients above the age of 45 years. Recertification may be considered in pilots older than 45 years of age if visual functions are restored and a specialist neurological examination demonstrates no pathology.

b *Central Serous Retinopathy*

The clinical course of this disease is very unpredictable. Usually visual functions are almost fully restored, leaving only a slight reduction in contrast sensitivity. Recertification may be considered if visual functions are restored and retinal oedema cannot be demonstrated by clinical nor by angiographic examinations.

c *Vascular occlusions*

Previous or present occlusion of the central retinal arteries and veins is not acceptable in pilots. Following branch occlusion, recertification may be considered if visual functions are restored and the presence of disqualifying pathology cannot be demonstrated by ophthalmic and medical examinations by accredited specialists.

d *Retinal detachment*

A retinal detachment will result in visual field defects and, in most cases, in reduced visual acuity as well. Even though vision may be restored by surgery, refractive errors and changes in eye motility may be significant side effects of the treatment. Recertification may be considered six months after successful surgery provided visual requirements are fulfilled.

e *Keratoconus*

This is a progressive corneal disease leading to severe astigmatism, corneal oedema and, in some cases, even to spontaneous corneal perforation. In its early stages, keratoconus may be treated with spectacles, later with contact lenses and, in the final stage, with corneal transplantation. Before surgery pilots may continue active flying if the visual requirements are fulfilled with use of corrective spectacles or contact lenses suitable for aviation purposes.

The pilot should be re-examined semi-annually by an ophthalmologist. After surgery, vide infra.

f *Corneal transplants*

Following a corneal transplantation, the refraction remains very unstable for a period of six to 12 months. Recertification may be considered one year after surgery if the visual requirements are fulfilled with use of correction suitable for aviation purposes, if the refraction is deemed stable and if there is no significant reduction of contrast sensitivity. The pilot should be re-examined by an ophthalmologist semi-annually.

12 GLAUCOMA

Glaucoma is the common name of several disorders, the most frequent being chronic open-angle glaucoma (COAG), angle-closure glaucoma (ACG), and secondary glaucomas.

COAG is an insidious disease with progressive optic nerve damage and visual field defects. It is usually combined with and possibly caused by increased intraocular pressure (IOP). Optic nerve fibres are supposedly destroyed by the combined action of raised IOP and impaired blood flow in the optic disc.

The mere presence of raised IOP is called ocular hypertension, and it involves an increased risk of developing COAG. This latter diagnosis is not ascertained by raised IOP alone, it demands the occurrence of either disc cupping or visual field defects.

The ACG is caused by the blockade of a narrow chamber angle. The IOP quickly rises to a high degree, there is reduced vision due to corneal oedema and severe pain, headache and nausea. If not treated, the condition gives rise to optic nerve damage as in COAG. The only way to anticipate an attack is by examination of the chamber angle, since the IOP is normal in the free intervals.

Secondary glaucomas are caused by conditions which interfere with the normal passage of the aqueous in the pupil or the chamber angle (e.g. anterior uveitis).

The first objective signs in the fundus are atrophy of nerve fibre bundles and cupping of the optic disc. The earliest changes are subtle and the diagnosis necessitates either progression or alterations of a certain magnitude. A rather substantial axon atrophy is present when visual field defects are first measurable. In most cases these are small paracentral scotomas within the central 15–25° of the field (Fig 16). Another early defect is the so-called nasal step, ie, a constriction of the upper or lower part of the paracentral nasal field (Fig 16). With progressive optic nerve damage, the cupping of the optic disc increases. Of help to record cup changes are the C/D ratio (a measure of the diameter of the cup in relation to that of the whole disc) and the rim area (the area of the outer rim of the disc with nerve fibres). If the disease process goes on, the cup usually first reaches the rim of the disc in either the lower or the upper pole. In severe cases, no rim of nerve fibres is seen at all, and the cup is deep or undermines the disc edges.

With progression of the disease, the scotomas increase in size and coalesce. One typical visual field defect in intermediate stages is the Bjerrum arcuate scotoma which stretches from the blind spot to the nasal field (Fig 16). The central part of the field is affected late in the disease as is the temporal peripheral field.

12.1 Methods of examination

The IOP is measured by tonometry. A simple but not so precise method is indentation tonometry (Schiotz). The deformation brought about by a certain weight on the cornea is measured and the result converted to IOP. In practice, the instrument is carefully placed on the anaesthetised eye of the supine subject.

A more precise measure of the IOP is given by applanation tonometry. Here, a certain minor deformation of the cornea is created and the pressure necessary directly converted to IOP. The apparatus is expensive and the examination demands some training.

An increased IOP, i.e. above about 25 mm Hg (policy on what is considered an 'alarm value' varies), or a difference between the eyes of 4 mm Hg or more should cause a suspicion of glaucoma. The applicant should then be referred to an ophthalmologist for repeated tonometry, assessment of visual fields and ophthalmoscopy.

Gonioscopy is the examination of the chamber angle with the aid of a corneal microscope and a special contact lens. The correct judgement of the chamber angle demands experience. If a narrow angle is found or the subject has had an attack of ACG, an iridectomy is done. After this minor procedure (today easily performed with a laser), there will be no (further) attack of high IOP and if the visual functions are intact, there is no reason for disqualification of service.

Visual field testing is essential to prove functional impairment. The examination should be done carefully with special emphasis on the defects typical of early glaucoma; it can be done manually by perimetry or campimetry or with an automated perimeter.

Provocative tests and tonography are not in current use.

12.2 Treatment

The treatment of glaucoma serves to reduce the IOP to a level at which no (further) damage to the optic nerve occurs.

Epinephrine (usually 1%; available also in a better penetrating composition of lower concentration) effectively reduces the IOP. It does not influence accommodation, but may increase the pupillary diameter and thereby provoke an attack of ACG. Short-term side-effects are rare, but after some years of treatment hyperaemia of the eyeball and irritation at instillation are usual.

Miotics increase the facility of outflow and by their parasympathetic action they also cause miosis and an accommodative spasm. Their pressure-reducing effect is good and reliable. The most frequently prescribed agent is pilocarpine (1–4%). It should be avoided in young patients with retained accommodation. In such cases it is better tolerated in the form of slowly releasing lamellas. Other miotic agents have long duration but are not much used since they increase the risk of cataract. Any type of miotic agent reduces retinal illumination whereby night vision is impaired.

Beta-blockers have rapidly become valuable aids in glaucoma treatment; their pressure-reducing effect is good and the side-effects are few. Because of their general effect on the autonomic nervous system, they are not to be used in cases of asthma or cardiac arrhythmias.

Carbonic anhydrase inhibitors such as acetazolamide reduce the aqueous production. They are given orally and are effective pressure reducers. Side-effects are tingling in the extremities, gastro-intestinal disturbances and a tendency to provoke the formation of renal calculi. Their main indication is short-term pressure reduction.

12.3 Practical considerations

The diagnosis glaucoma does not per se disqualify from continued service. Even small paracentral scotomas do, however, constitute a safety risk in aviation personnel. The applicant with glaucoma should fulfil the following requirements:

- a All visual requirements.
- b No side-effects from the treatment given. Of the side-effects, the most important is the accommodative reduction of the visual acuity. This possible impairment can easily be tested by measurement of the visual acuity for one hour every 10 minutes after instillation of eye-drops.
- c Periodic follow-up examination of the visual function under the treatment given at the discretion of the AMS.

Subjects with ocular hypertension should be regularly examined at an individual basis in order to disclose the possible debut of COAG.

13 MONOCULARITY

In persons with only one eye, the perception of depth and distance is reduced, the visual field is smaller, and the risk of acute visual incapacitation is significantly increased. For those reasons, a one-eyed person cannot be accepted as fit for flying. If the visual acuity in one eye is reduced to 6/24 or below, the person is functionally one-eyed except for the visual fields. One-eyed persons may to some degree adapt to their condition and may thus perform quite well in everyday life.

Recertification may be considered in professional pilots with functional monocularly i.e. reduced central vision but normal binocular visual fields, whereas qualified private pilots may be considered for recertification after total loss of one eye (or loss of vision in one eye or reduction of visual acuity to a significant degree in one eye) provided the condition has been stable for a period of more than six months. In both cases the underlying pathology must be assessed as acceptable following examination by accredited specialist in ophthalmology and the good eye should fully meet all requirements. Furthermore, the pilot should demonstrate his flying ability by a medical flight test prior to final assessment.

For professional pilots, the certificate should be restricted to multi-crew only ('as or with qualified co-pilot only'). For private pilots with only one eye, goggles are recommended; for those pilots flying aircraft with open cockpit, goggles or better a flying helmet with visor should be mandatory.

INTENTIONALLY LEFT BLANK

KEY TO OPHTHALMOLOGICAL EXAMINATION PROCEDURES

CLASS 1	EXAMINATION			MANUAL REFERENCE
	A	B	C	
Distant visual acuity (the appropriate Snellen's chart or equivalent) corrected if required.	3	3	3	2.3
Refractive state (subjective dilated refraction, assessment of own spectacles)	3	3	As indicated	4 and 4.2
Accommodation, amplitude of (near point rule)	3	3	3	3, 3.1 and 3.2
Convergence, nearpoint of (near-point rule)	3	3	3	9.4 and 9.5
Near and intermediate vision at 30-50 and 100 cms (N-system) with and without correction	3	3	3	3
Visual fields (confrontation)	3	3	3	8 and 8.3
Colour vision (Ishihara unilaterally), Nagel's anomaloscope, lantern test when indicated	3	3	As indicated	10.4
Eyelids, external eye (objective examination)	3	3	3	1.3
Eye position and movements (pencil light, cover test/hess screen)	3	3	3	9.5
Heterophoria at 5 or 6 metres and 30 cms. (cover test, variable prism, maddox cross, maddox wing).	3	3	As indicated	9.2 and 9.5
Pupillary reflexes	3	3	3	1.3
Exterior part of the eye, conjunctiva, cornea, pupil, iris, lens, etc	Slit lamp	>50 2yrl	Ophthalmoscope	
Fundus of the eye (ophthalmoscopy) with dilation if necessary to gain an adequate view		3	3	
Intra-ocular tension (tonometry)	3_	>50 2yrly		12.1

- comprehensive initial aeromedical examination for first issue of medical certificate
- comprehensive renewal ophthalmological examination depending on age : 5-yearly to age 40 then 2-yearly to age 65
- routine renewal aeromedical examination

The usual or recommended method of examination is mentioned in brackets

On indication and where equipment available tests may include

campimetry, auto-perimetry, auto-refraction, retinoscopy, binocular fusion (prism test, worth 4-dot test, synoptophore, stereotests), contrast sensitivity

* NOTE: Ishihara charts only unless change from initial assessment

KEY TO OPHTHALMOLOGICAL EXAMINATION PROCEDURES

CLASS 2	INITIAL EXAMINATION	RENEWAL EXAMINATION	MANUAL REFERENCE
Distant visual acuity (the appropriate Snellen's chart or equivalent)	3	3	2
Refractive state (subjective refraction, assessment of own spectacles) autorefraction retinoscopy	3	3	4 and 4.2
Accommodation amplitude of (Raf near-point rule)	3	3	3, 3.1 and 3.2
Convergence, near point of (Raf near-point rule)	3	3	9.4 and 9.5
Near and intermediate vision at 30–50 and 100 cms (N-system, glasses)	3	3	3
Visual fields (<u>confrontation</u> method a.m. Donders) campimetry auto-perimetry)	3	3	8 and 8.3
Colour perception (Ishihara unocularly) (Nagel's anomaloscope, colour lantern test when indicated)	3	*	10.4
Eyelids, external eye (objective examination)	3	3	1.3
Eye position and eye movements (pencil light, cover test)	3	3	9.5
Heterophorias at 5 or 6 metres (cover test, prism rod, maddox Cross, worth 4-dot test)	3	3	9.2 and 9.5
Pupillary reflexes	3	3	1.3
Fundus of the eye (ophthalmoscopy)		3	

* NOTE: The requirements for each renewal examination are the same with the exception of colour perception, which should only be repeated when indicated.

INTENTIONALLY LEFT BLANK